



DECORAN

designul care te înconjoară

Outdoor 03

Decking WPC. 04

Lambriuri și Riflaje WPC 06

Plăci de gard WPC. 08

Panouri flexibile din piatră 09

Pergole 14

Panouri pentru Placări 18

Panouri cărbune de bambus 18

Panouri din compozit mineral 19

Panouri din compozit mineral ABCD 22

Panouri din cristal carbon. 25

Panouri decorative din PU 30

Panouri Acustice 37

Riflaje 48

Riflaje flexibile din MDF 48

Riflaje rigide din polimer 54

Plante Artificiale 61

Aranjamente de perete tip panou, cu ramă. 61

Aranjamente florale suspendate 63

Panouri din plante ABC 65

Panouri cu flori 67

Covoare din mușchi artificial 69

Imitații de gard viu. 71

Plasă de gard 71

Plinte din Polimer Rigid 74

Outdoor

Transformă-ți spațiul exterior cu idei de amenajări exterioare pentru curte și grădină, potrivite pentru orice tip de locuință. De la amenajări exterioare de curți și grădini mici, până la amenajare exterior casa, îți oferim soluții creative pentru un ambient plăcut și funcțional.

Fie că este vorba de o amenajare curte exterioară sau de o grădină decorată cu piatră decorativă, pavaje sau trepte, vei găsi idei și produse care se potrivesc perfect stilului dorit. Inspiră-te din varietatea noastră de amenajări exterioare casa și grădină și oferă locuinței tale o nouă identitate.

Pentru proiecte personalizate, îți punem la dispoziție amenajări curți cu pavaje și trepte, dar și idei de aranjamente exterioare curte care să aducă un plus de eleganță. Redefinește-ți spațiul exterior și bucură-te de o atmosferă relaxantă și modernă. Descoperă ideile noastre de amenajare și începe transformarea!



Decking WPC (Wood Plastic Composite)

Pardoselile din WPC (Wood Plastic Composite) reprezintă o soluție modernă, durabilă și estetică pentru spațiile exterioare. Acestea combină aspectul natural al lemnului cu rezistența și longevitatea plasticului, oferind o pardoseală care este rezistentă la intemperii, umiditate și deteriorare. Pardoselile din WPC sunt utilizate în principal în exterior, datorită proprietăților lor de rezistență la umezeală și variații climatice.

Acestea sunt ideale pentru: *Terase și balcoane*, oferind un aspect plăcut și natural, fără a necesita întreținerea riguroasă a lemnului tradițional; *Spații în jurul piscinelor*, datorită rezistenței la apă și alunecare; *Alei în grădini sau curți*; *Platforme și pontoane*, fiind rezistente la expunerea directă la apă.

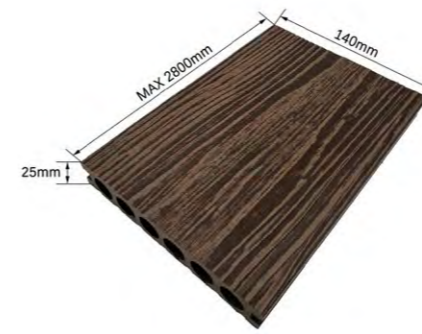

D7480

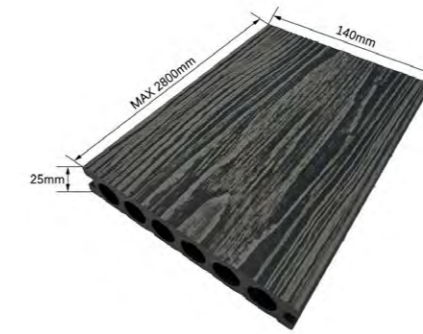

D7481

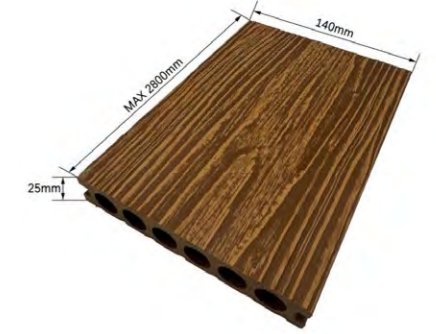

D7482

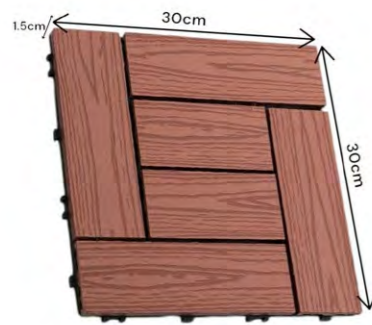

D6252

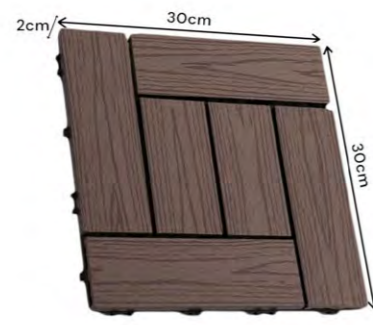

D6253

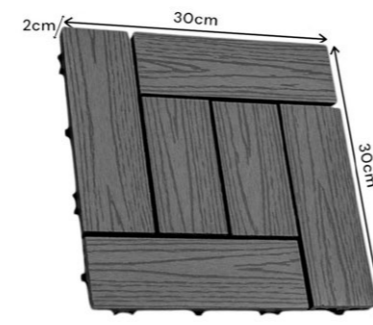

D6254

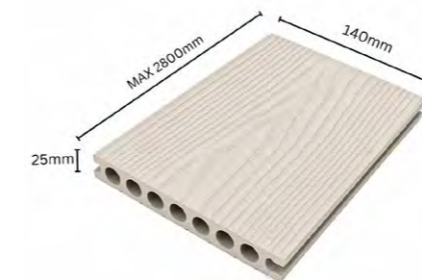

D7483



D7484

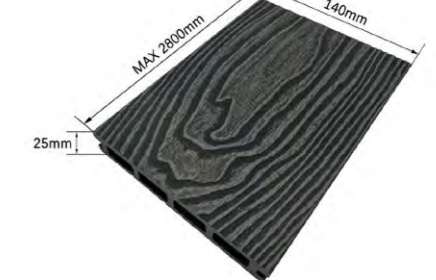

D7485



D6463



D6464

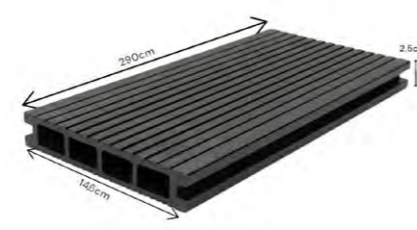

D6465

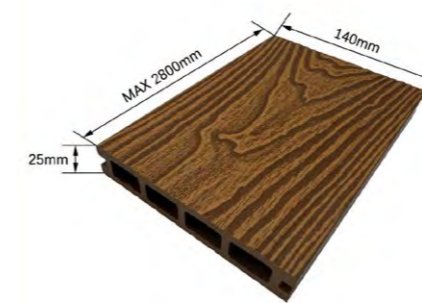

D7486

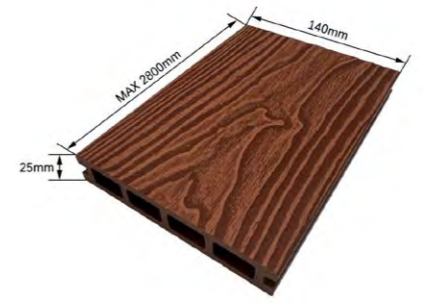

D7487

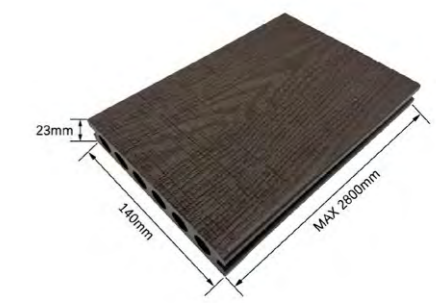

D7488



D6483

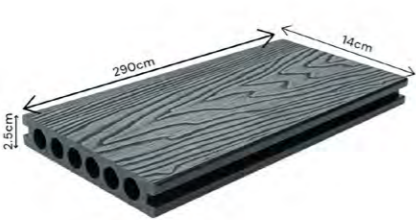

D6484

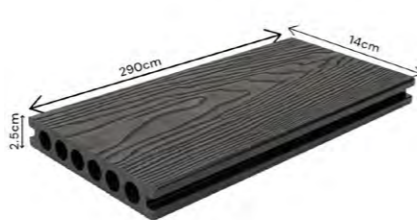

D6485

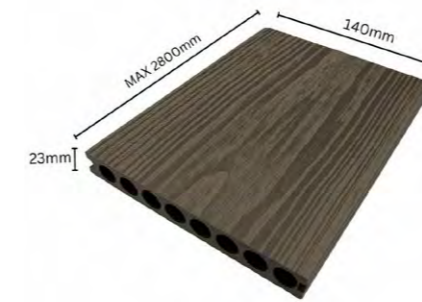

D7489

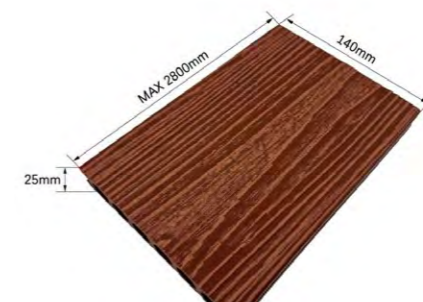

D7522



Lambriuri și Riflaje WPC (Wood Plastic Composite)

Lambriurile decorative riflate din WPC (Wood Plastic Composite), realizate din fibră de bambus și PVC, sunt soluții inovatoare pentru decorarea fațadelor, gardurilor și altor suprafețe exterioare cât și interioare. Acestea combină natura lemnului (prin utilizarea fibrei de bambus) cu durabilitatea materialelor sintetice (PVC), oferind un produs estetic, rezistent și ușor de întreținut. Sunt ideale pentru aplicații exterioare, aducând un plus de eleganță și funcționalitate oricărui spațiu. **Panourile decorative riflate din WPC (Wood Plastic Composite)**, realizate din fibră de bambus și PVC, sunt soluții ideale pentru decorarea pereților și tavanelor.



D6490

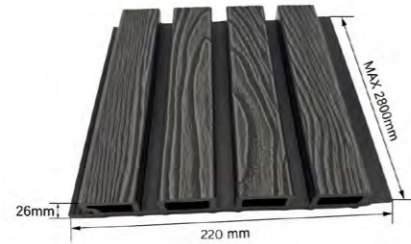

D6491



D6492

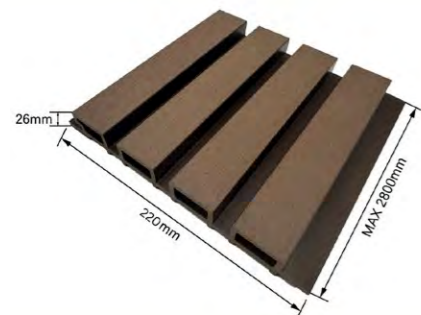

D6493

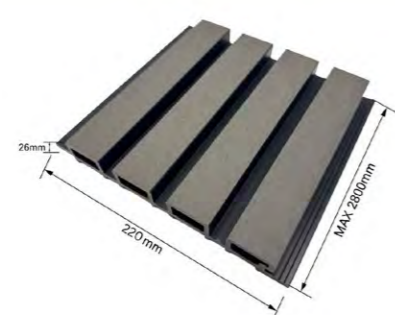

D6494

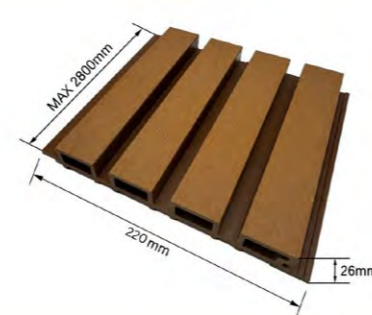

D6495

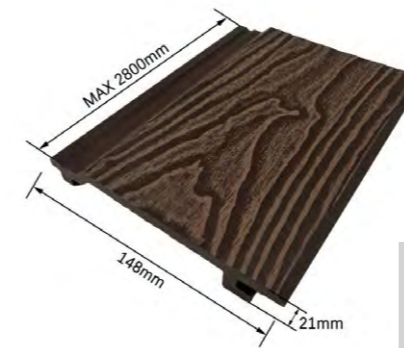

D6496

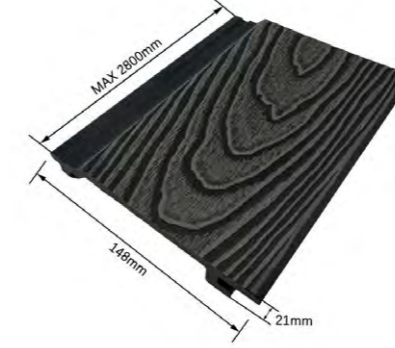

D6497

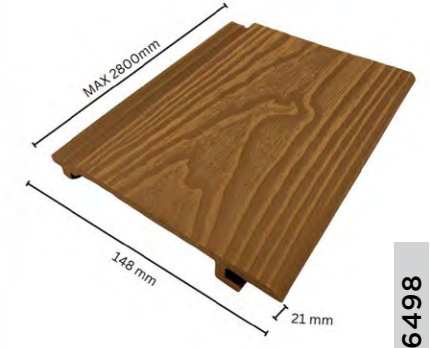

D6498



D7551



D7552



D7553



D7554



D7555



D7556

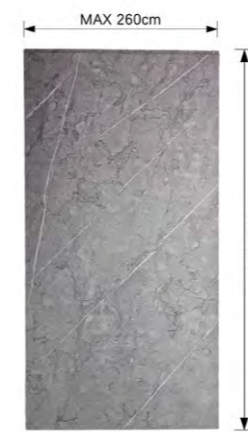

D7557



D7558



Plăci de gard WPC (Wood Plastic Composite)

Un profil de gard din WPC (Wood Plastic Composite) este o soluție modernă și durabilă pentru delimitarea proprietăților oferind un aspect estetic de lemn, dar fără problemele asociate acestuia. Acest tip de profil se montează pe un stâlp de 1,87 m, cu o bază de 7x7 cm, care asigură stabilitate și rezistență structurii.

Ideale pentru - Împrejmuirea grădinilor și curților: Sunt excelente pentru delimitarea proprietăților, oferind atât protecție, cât și intimitate. **Spații rezidențiale:** Oferă un aspect modern și natural, fără a necesita întreținerea periodică. **Zone comerciale sau industriale:** Datorită durabilității și rezistenței lor la intemperii, sunt o soluție bună pentru delimitarea spațiilor comerciale sau industriale. **Spații publice:** Pot fi folosite pentru a delimita parcuri, terenuri de joacă sau alte zone publice, având o estetică plăcută și o rezistență crescută. **Proiecte de amenajare peisagistică:** Pot fi integrate armonios în grădini sau alte proiecte de amenajare a spațiilor exterioare, oferind un decor plăcut și de durată.

Avantaje ale profilului din WPC - Durabilitate: Rezistent la intemperii, nu se deformează, nu putrezește și nu este afectat de insecte, cum ar fi lemnul natural. **Întreținere minimă:** Spre deosebire de lemn, nu necesită tratamente anuale de lăcuire sau vopsire. Poate fi curățat cu apă și detergent ușor. **Aspect estetic de lemn:** Oferă un design modern și elegant, imitând textura și culoarea lemnului. **Rezistență la UV:** Nu se decolorează ușor sub acțiunea razelor solare. **Montaj ușor:** Sistemul modular permite o instalare simplă, rapidă, fără necesitatea unor unelte complexe. **Ecologic:** WPC-ul este un material ecologic, obținut din materiale reciclate.



D6472



D6473



D6474



Panouri flexibile din piatră

Sunt realizate dintr-o compoziție de praf de piatră naturală aplicată uniform pe o plasă de fibră de sticlă, având o textură fin granulată ce conferă flexibilitate și stabilitate dimensională. Materialul este uscat și întărit printr-un proces termic controlat, rezultând o structură compactă, rezistentă și durabilă.

În etapa finală, suprafața este pulverizată cu un strat subțire de ceramică, aplicat prin tehnologie de tip template spray. Acest strat ceramic oferă un finisaj elegant și protecție superioară împotriva zgârieturilor, umezelii și razelor UV, menținând aspectul autentic al pietrei naturale și prelungind durata de viață a produsului. Sunt soluția ideală pentru placări decorative moderne, oferind durabilitate, estetică premium și montaj rapid.

Flexibile - se pot îndoi și adapta pe colțuri sau pereți curbați.

Greutate redusă - ușor de transportat și montat.

Rezistență la razele UV și ignifuge - potrivite pentru utilizare atât la interior, cât și la exterior.

Disponibil în mai multe modele și culori - pentru a se integra perfect în orice stil de amenajare.

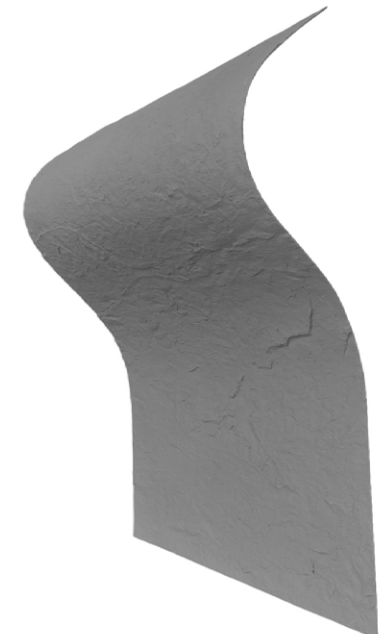

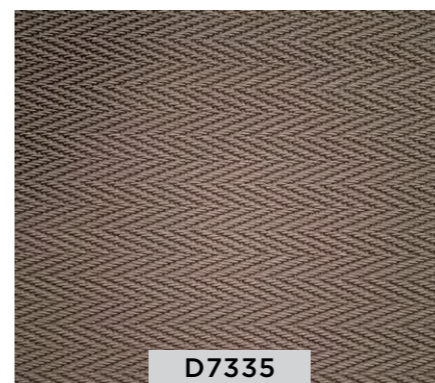
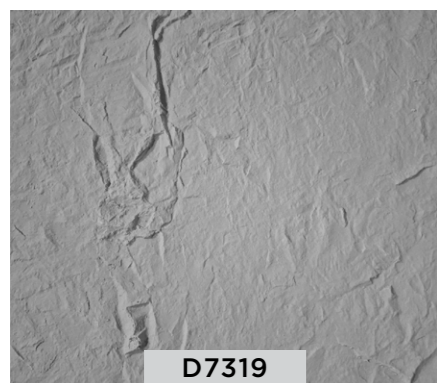
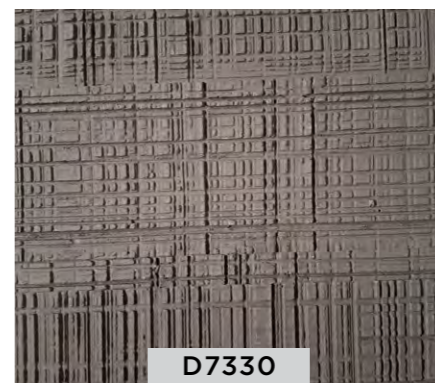
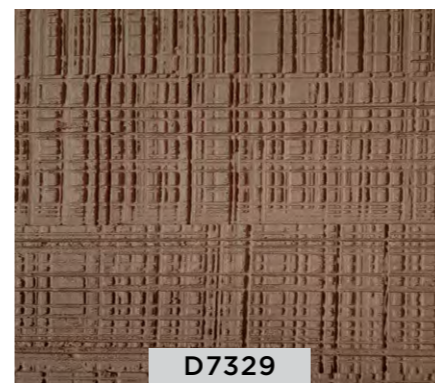
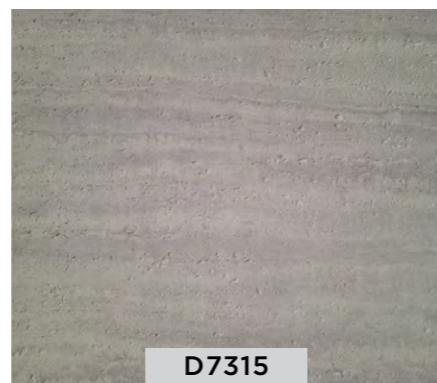
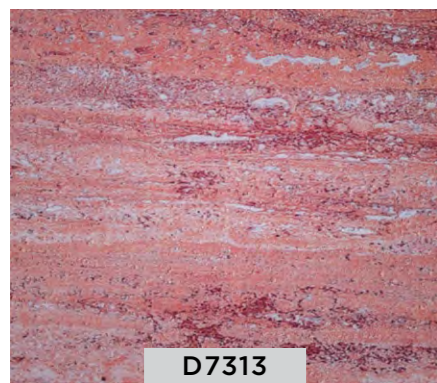
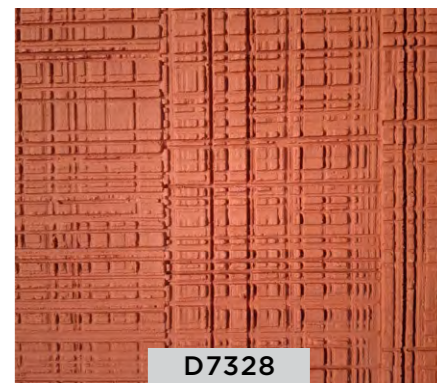
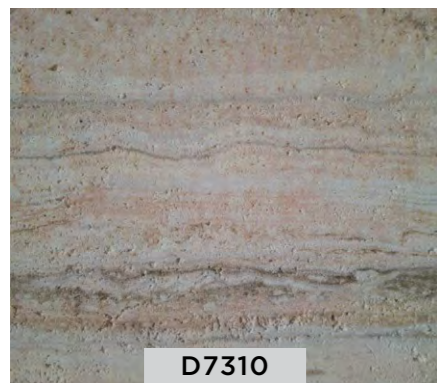
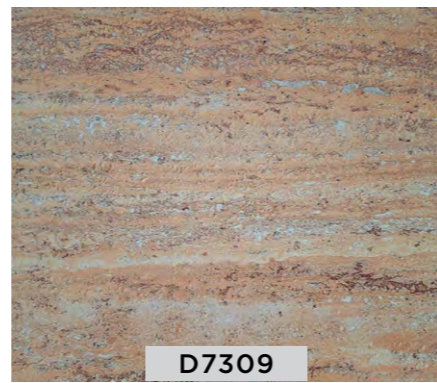



D7338

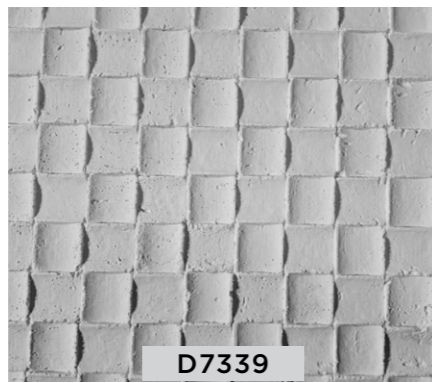

D7339



D7340

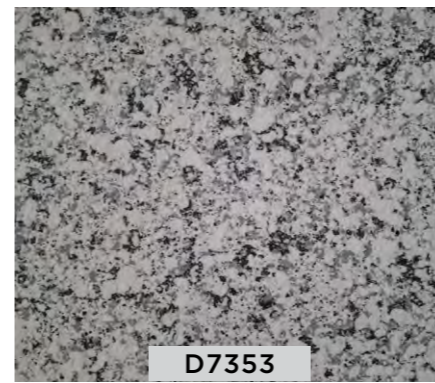

D7353

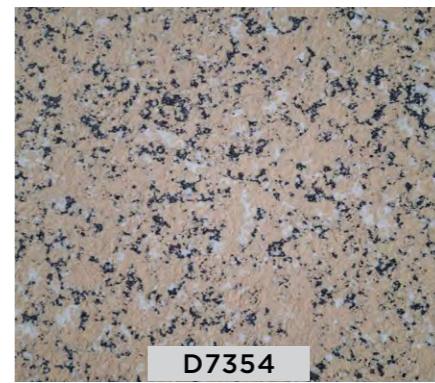

D7354

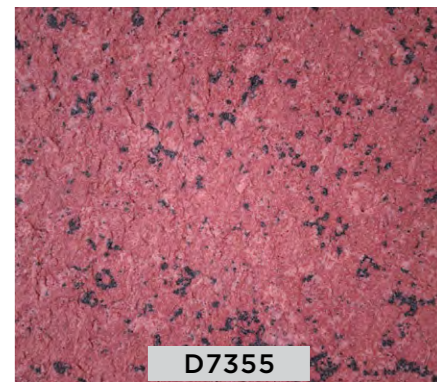

D7355



D7341



D7342



D7343

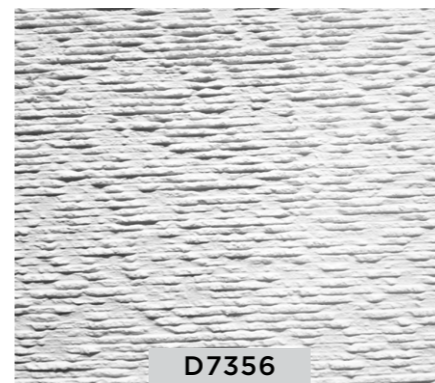

D7356



D7357



D7358

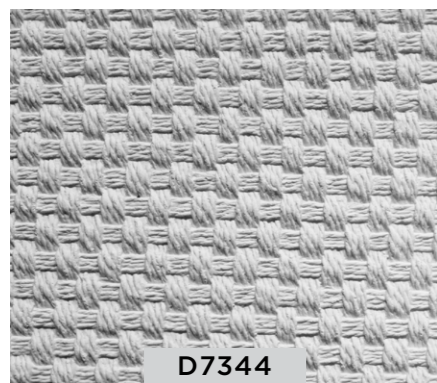

D7344



D7345



D7346



D7359



D7360

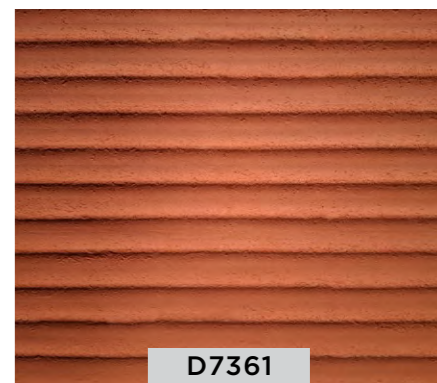

D7361



D7347



D7348



D7349

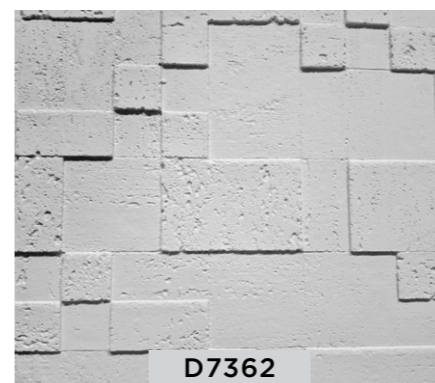

D7362



D7363



D7364



D7350



D7351



D7352

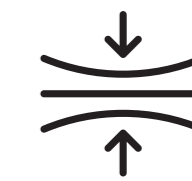

Pergole

O pergolă bioclimatică este compusă din mai multe elemente structurale și funcționale care contribuie la aspectul său modern și la performanța sa de protecție împotriva intemperiilor. Pergola bioclimatică din aluminiu este alegerea ideală pentru terasa dumneavoastră, putând fi folosită indiferent de condițiile meteorologice.

Durabilitatea și structura compactă sunt cuvintele care descriu cel mai bine caracteristicile acesteia alături de confortul și designul modern. Acest sistem cu structura din aluminiu, care nu necesită întreținere specială, oferă protecție împotriva ruginii, poate fi punctul de atracție al grădinii dumneavoastră. Faptul că oferă protecție împotriva intemperiilor vă permite să vă bucurați de aceasta pergolă atât vara, cât și iarna și este recomandată în multiple destinații, cum ar fi restaurante și cafenele, hoteluri și chiar centre comerciale.

Datorita lamelelor retractabile, razele solare pot pătrunde mai mult sau pot fi blocate complet, beneficiind astfel de un spațiu aerisit și cu lumina adaptată. De asemenea, pentru a spori confortul utilizatorului se pot utiliza o serie largă de accesorii, precum: LED-uri, senzori de vânt, senzori de soare etc. Opțional, pergolei i se pot atasa sisteme de închidere fixe sau mobile cu sticlă securizată. Pergola cu lamele retractabile-bioclimatică, vopsită în camp electrostatic asigură o rezistență sporită împotriva exfolierii și a decolorării vopselei.



D6783

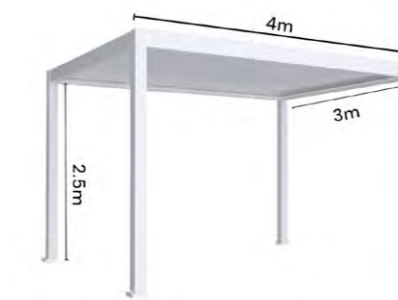

D6785



D6802



D6786



D6787

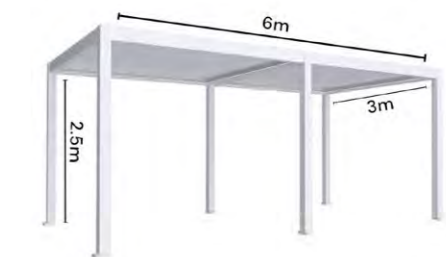

D6788

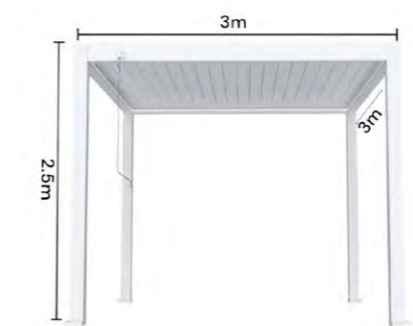

D6791



D6791

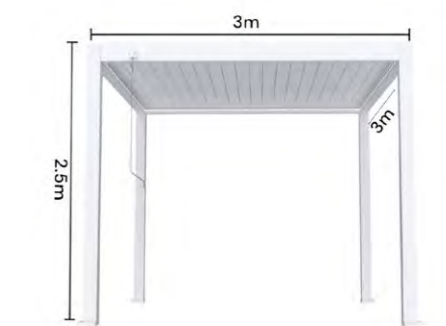

D6801

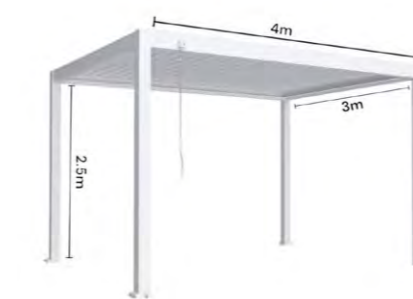

D6804



D6794

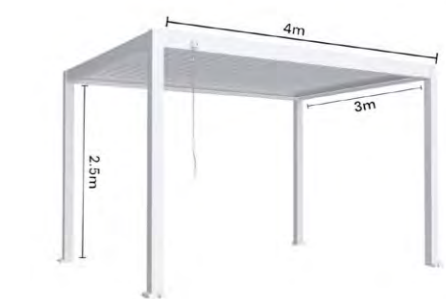

D6796





DESCHIDE LAMELELE
când este soare pentru a
permite luminii să intre



ÎNCHIDE LAMELELE
pentru umbră
sau atunci când plouă



1. STRUCTURA PRINCIPALĂ

Stâlpi de susținere: De obicei, realizate din aluminiu sau oțel inoxidabil, aceștia oferă stabilitate și susțin întreaga structură. Stâlpii sunt rezistenți la intemperii și sunt disponibili în diverse finisaje

Grinzi și cadre laterale: Acestea conectează stâlpii și formează cadrul superior al pergolei, sprijinind lamelele orientabile. Aceste grinzi sunt, de obicei, tot din aluminiu sau oțel, pentru durabilitate și rezistență.

2. LAMELELE ORIENTABILE

Material: Lamelele sunt realizate din aluminiu extrudat, rezistent la coroziune și intemperii, ceea ce asigură o durată lungă de viață și un aspect modern.

Funcție: Lamelele se pot roti pentru a regla cantitatea de lumină solară și ventilația. Când sunt complet închise, lamelele oferă protecție împotriva ploii și a soarelui intens.

Mecanism de control: Reglarea lamelelor poate fi manuală sau motorizată, prin intermediul unei telecomenzi sau a unui sistem automatizat conectat la senzori de vreme.

3. SISTEMUL DE DRENAJ

Jgheaburi și scurgeri: Pergolele bioclimatice sunt dotate cu un sistem de drenaj pentru a colecta apa de ploaie de pe lamelele închise și a o direcționa către scurgerile laterale, evitând astfel acumularea de apă pe suprafața pergolei.

4. ELEMENTELE SUPLIMENTARE (OPȚIONALE)

Panouri laterale sau rulouri: Acestea pot fi din sticlă, material textil sau PVC transparent și oferă protecție suplimentară împotriva vântului, ploii sau chiar insectelor.

Încălzitoare: În zonele reci, pergola poate fi dotată cu sisteme de încălzire integrate, pentru a asigura confortul chiar și în sezonul rece.

5. SISTEMELE DE ANCORARE

Fixații la sol: Stâlpii sunt ancorați la sol cu ajutorul unor baze solide, fie prin prindere directă în beton, fie prin șuruburi speciale. Acest lucru asigură stabilitatea structurii, chiar și în condiții de vânt puternic.



Panouri pentru Placări



Panouri din compozit mineral

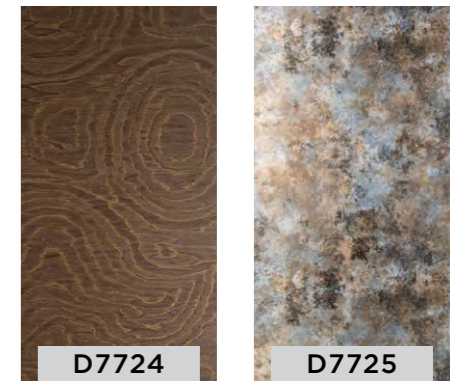
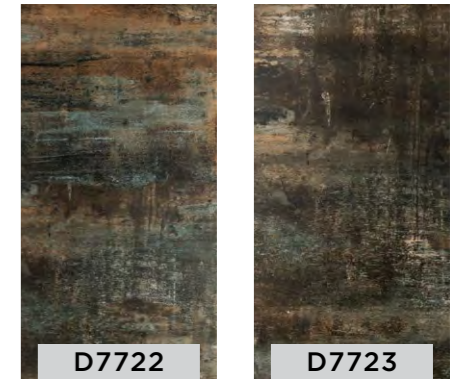

Panouri cărbune de bambus



80 x 122 cm
D6397



80 x 122 cm
D6498



80 x 122 cm
D6499

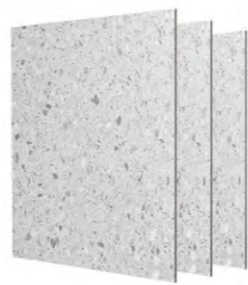
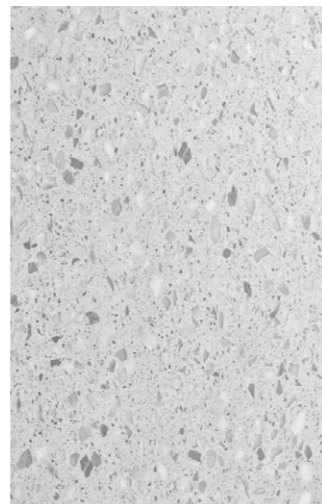

80 x 122 cm
D6501

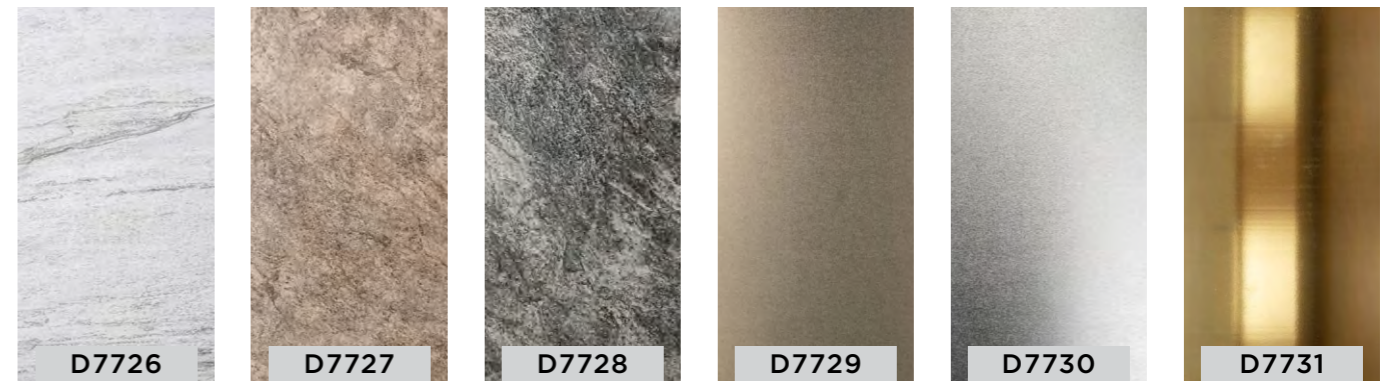

D7726

D7727

D7728

D7729

D7730

D7731



D7732

D7733

D7734

D7735

D7736

D7737



D7738

D7741

D7742

D7743

D7744

D7745

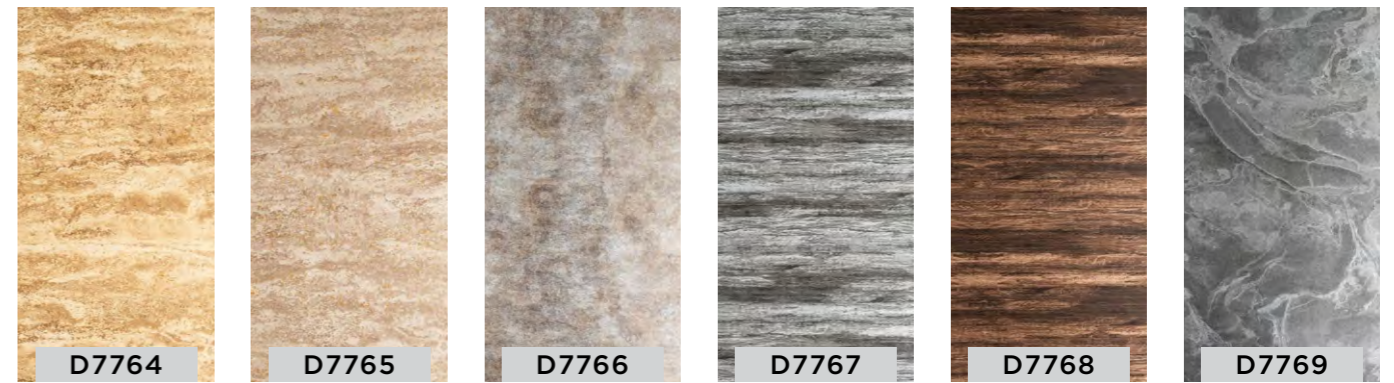

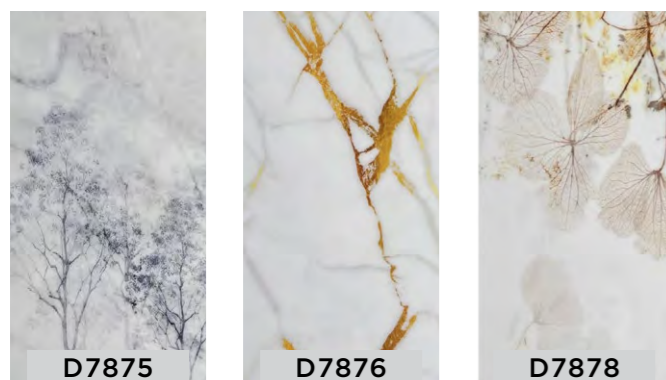
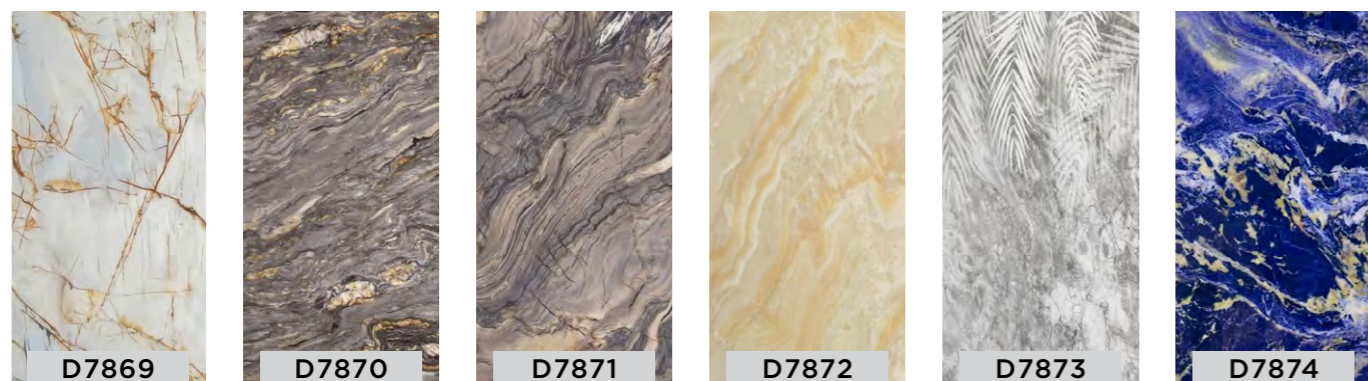
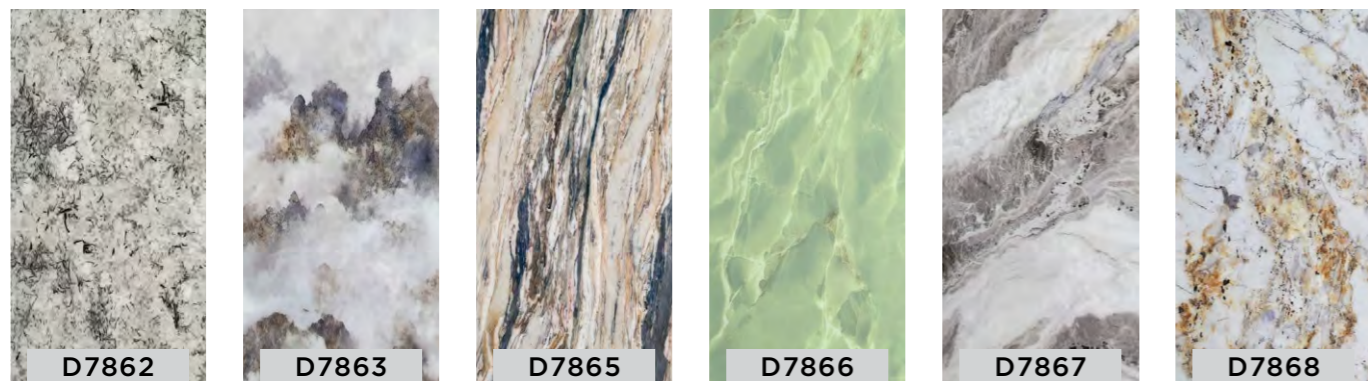

Panourile decorative din PVC și calcar oferă un echilibru ideal între rezistență, siguranță și design premium, cu îmbinare continuă pentru un aspect modern și uniform, acoperind o suprafață generoasă de 13.44m² (3.36m²x4).

Datorită densității ridicate asigură stabilitate excelentă, durabilitate superioară și întreținere ușoară.

Sunt antibacteriene, ignifuge și rezistente la umiditate, fiind potrivite atât pentru spații rezidențiale, cât și comerciale. Îmbinarea continuă oferă panourilor un aspect uniform, cu rosturi foarte discrete între ele. Modelul se aliniaza dintr-un panou în altul, astfel încât suprafața finală să pară cât mai coerentă și bine finisată.

Panouri din compozit mineral ABCD

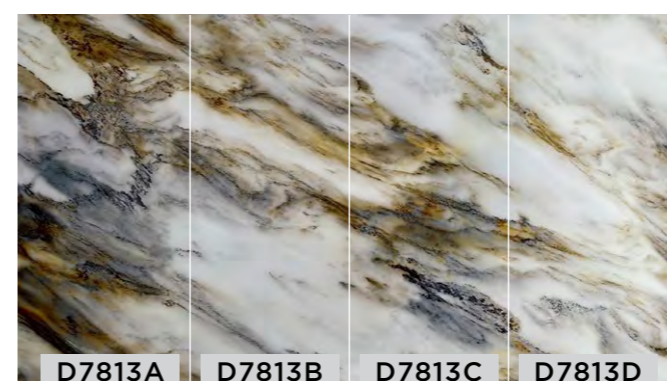
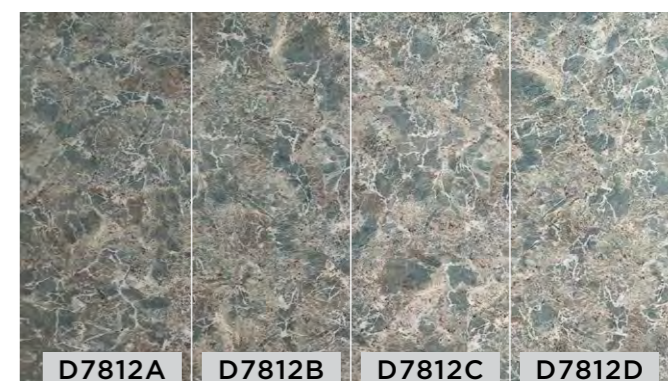
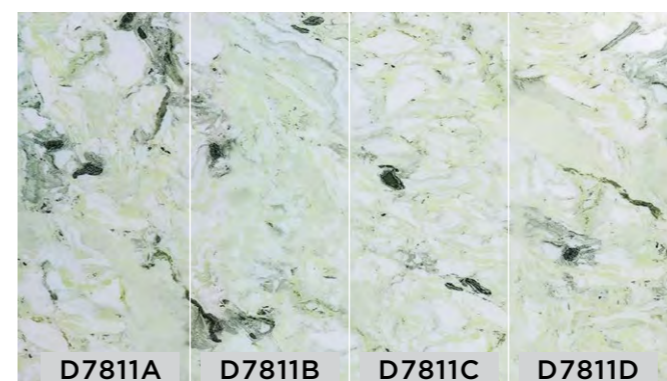
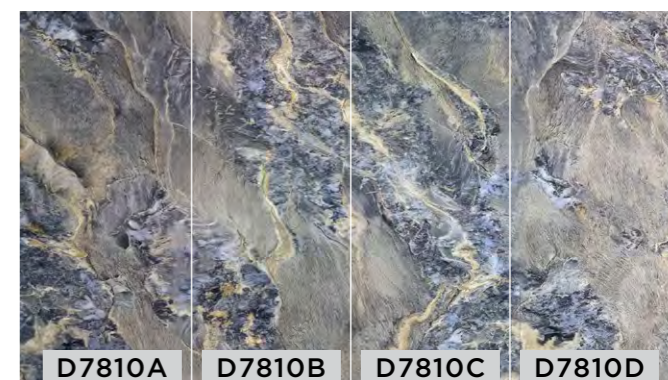
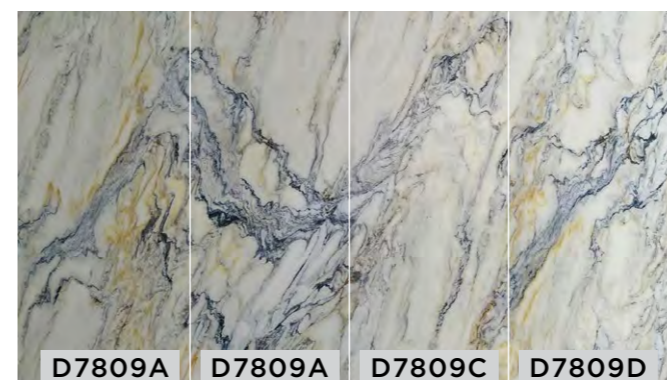
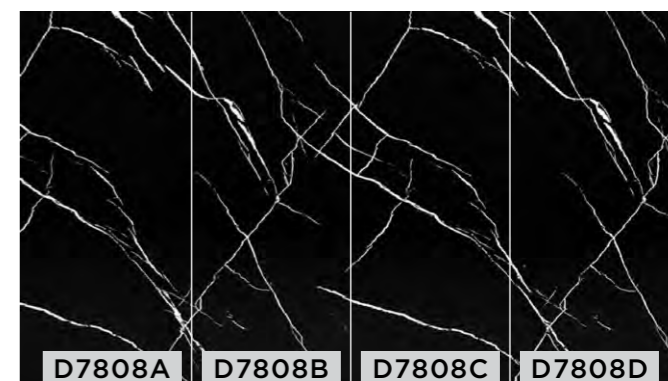
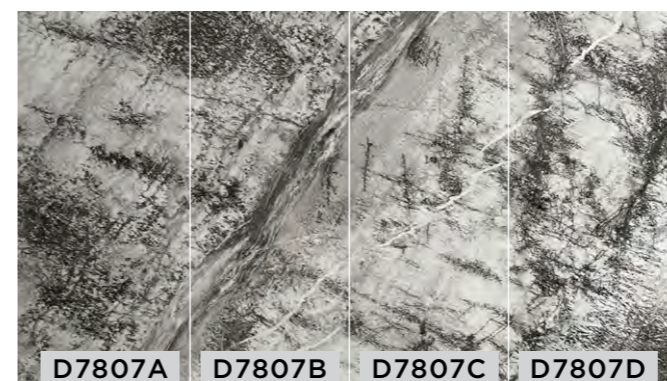
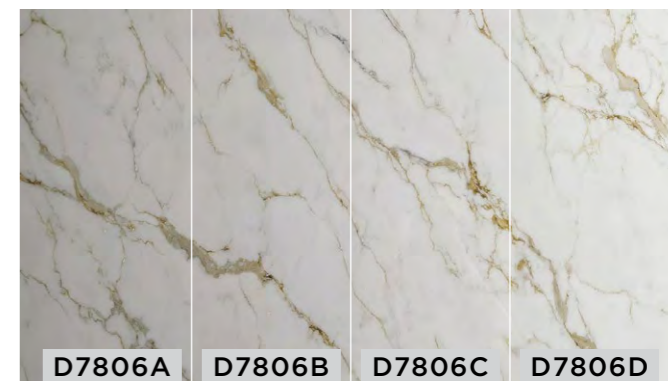
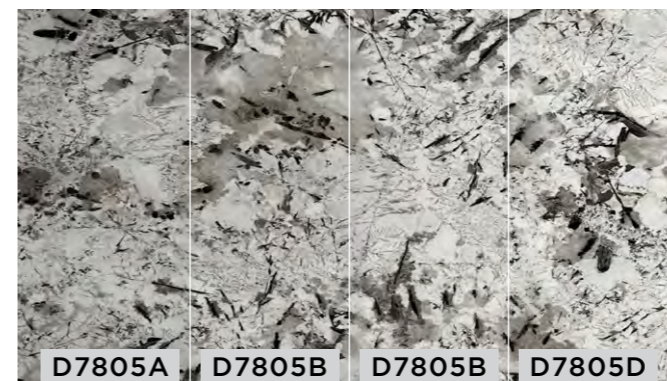
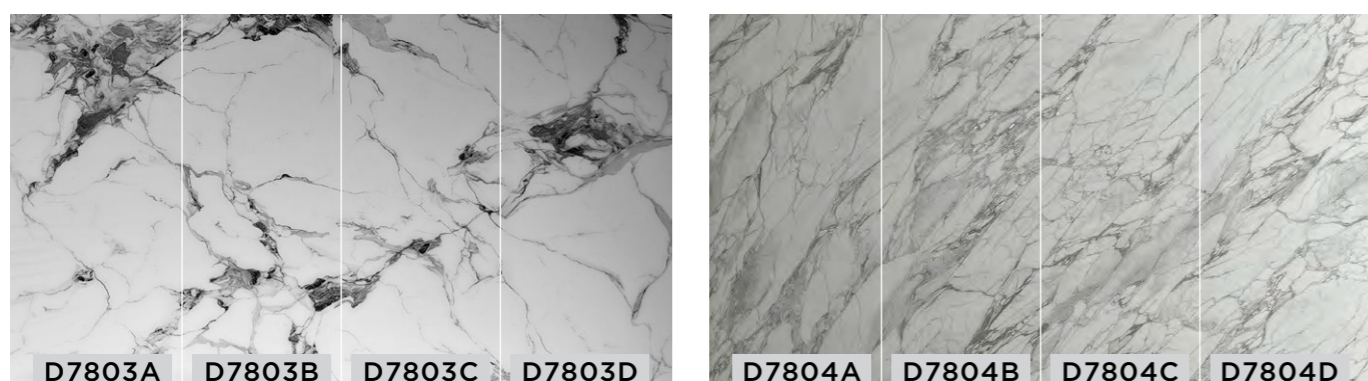

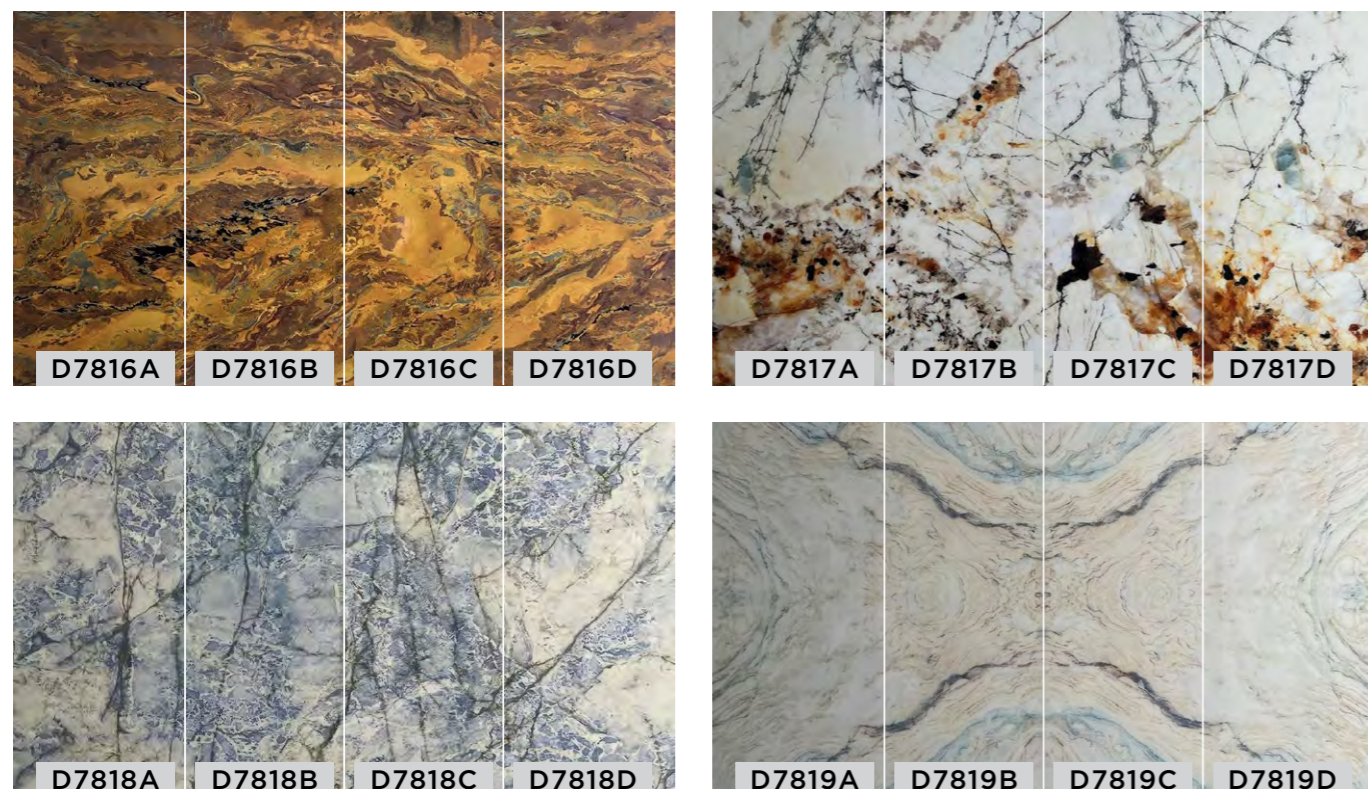

Recomandări de utilizare și întreținere

- Pentru un montaj sigur și durabil se recomandă folosirea adezivilor compatibili și evitarea celor agresivi.
- Panourile se curăță ușor cu o lavetă moale și soluții delicate, iar pentru menținerea finisajului premium este indicată evitarea obiectelor abrazive.
- Materialul oferă un finisaj modern și elegant, nu favorizează apariția mușgaiului sau a dăunătorilor și asigură un raport calitate-preț avantajos.

Structura panoului

- Stratul superior transparent protejează suprafața panoului împotriva zgârieturilor, petelor și uzurii zilnice. Asigură rezistența în timp și întreținerea ușoară.
- Stratul decorativ reprezintă designul vizibil al panoului. Oferă aspectul premium și realismul materialului natural.
- Stratul de co-extrudare îmbunătățește aderența între straturi și contribuie la stabilitatea generală a panoului.
- Substratul de SPC este nucleul panoului, realizat din compozit mineral și polimer. Oferă rigiditate și stabilitate dimensională, rezistența la umiditate, durabilitate ridicată și nu se deformează în timp.
- Stratul de co-extrudare spată este stratul de bază care stabilizează panoul și asigură o fixare corectă pe perete. Contribuie la rezistența generală și la montajul uniform.

Sistemul de îmbinare interlocking

Este un sistem special de îmbinare în care panourile se fixează unul în altul, formând o suprafață continuă, stabilă și uniformă.

Panouri din cristal carbon

Panourile din cristal de carbon revoluționează industria construcțiilor. Compoziția lor unică combină rezistența, ușurința și durabilitatea, făcându-le materiale ideale pentru aplicațiile moderne.

Panourile din cristal de carbon oferă, de asemenea, versatilitate estetică. Sunt disponibile într-o varietate de finisaje și designuri, permițând expresia arhitecturală creativă și inovatoare. Această flexibilitate le face potrivite pentru o varietate de stiluri arhitecturale, de la clădiri elegante și moderne până la designuri mai tradiționale.

Durabilitatea panourilor din cristal de carbon reduce necesitatea înlocuirii frecvente și minimizează deșeurile din construcție. Acest lucru este în concordanță cu tendința de creștere a practicilor de construcție durabile, făcându-le perfecte pentru proiectele ecologice.

O caracteristică proeminentă a panourilor din cristal de carbon este conductivitatea lor termică, care poate îmbunătăți considerabil eficiența energetică a clădirilor. Aceste panouri pot ajuta la menținerea unei temperaturi interioare constante reducând nevoia de încălzire sau răcire excesivă.





89 x 120 cm

D6629

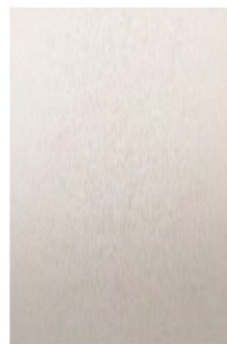

89 x 120 cm

D6632



89 x 120 cm

D6646



89 x 120 cm

D6648

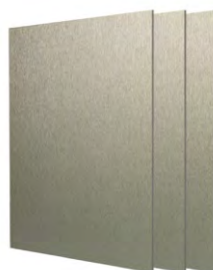
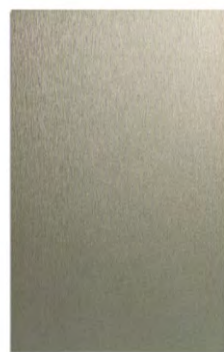

89 x 120 cm

D6634



89 x 120 cm

D6635



89 x 120 cm

D6649



89 x 120 cm

D6650



89 x 120 cm

D6637



89 x 120 cm

D6638



89 x 120 cm

D6651

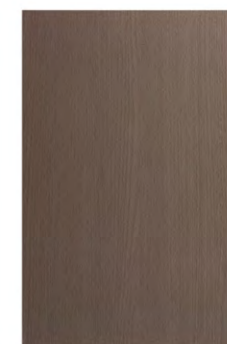

89 x 120 cm

D6652



89 x 120 cm

D6640



89 x 120 cm

D6641



89 x 120 cm

D6653



89 x 120 cm

D6654

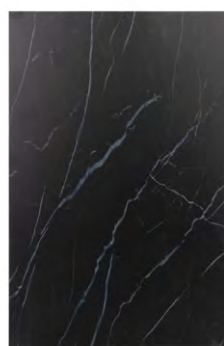

89 x 120 cm

D6642

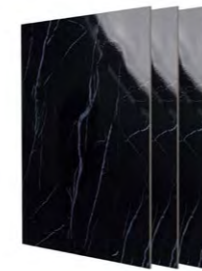
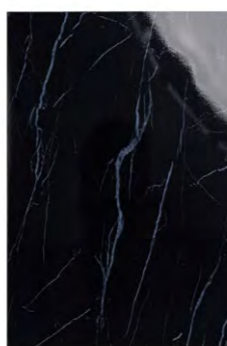

89 x 120 cm

D6643



89 x 120 cm

D6655



89 x 120 cm

D6656

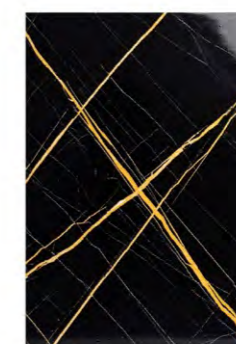
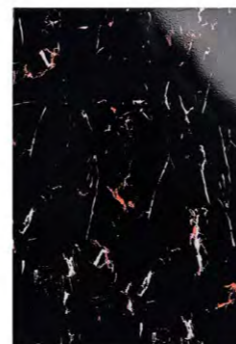
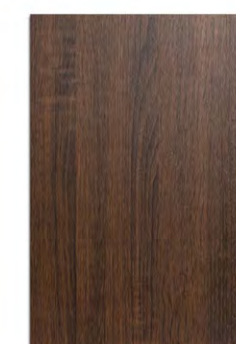
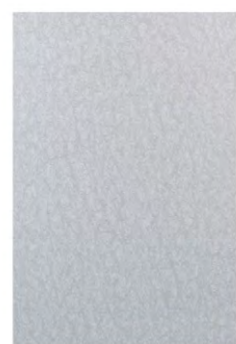
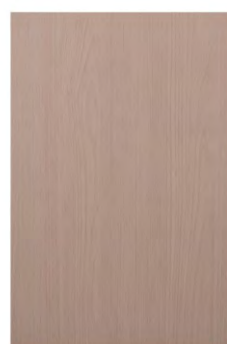
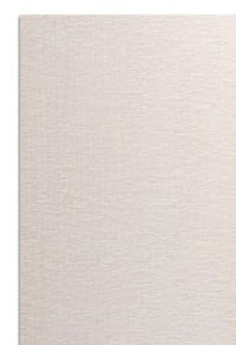
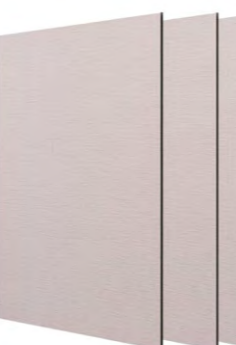
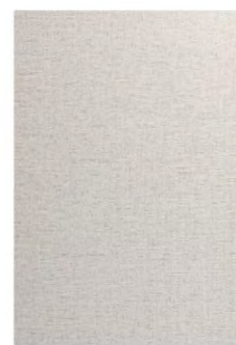
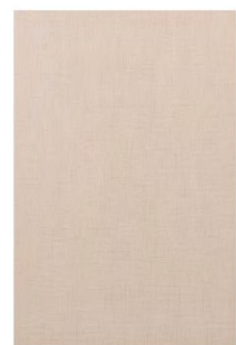

Cu design minimalist și funcționalitate avansată, panourile cu cristal de carbon adaugă un plus de stil și eficiență oricărui spațiu. Aceste panouri sunt ușor de instalat și nu necesită întreținere complexă, fiind ideale pentru locuințele moderne. Fie că optezi pentru un model mai compact sau pentru unul mai mare, aceste panouri îți vor transforma spațiul într-o oază de confort!



Panouri decorative din PU

Adaugă profunzime și textură spațiului tău cu aceste panouri decorative de perete din PU, care oferă un efect 3D realist și captivant. Designul detaliat și reliefat creează o suprafață tridimensională, aducând un plus de eleganță și rafinament în orice încăpere.

Realizate din PU (poliuretan), aceste panouri sunt ușoare și durabile în același timp, oferind o soluție rezistentă și longevivă pentru decorarea interioarelor, unele modele putând fi folosite și pentru proiecte exterioare protejate. Având o greutate redusă, este ușor de manevrat și montat, fără a fi necesare echipamente sau abilitați speciale.

Acestea se pot fixa cu ușurință pe orice perete prin metode standard de asamblare sau cu adezivi de construcție. Sunt rezistente la zgârieturi, lovituri ușoare și alte deteriorări, asigurând o înfățișare impecabilă pe termen lung.

Pot fi utilizate în diverse încăperi, inclusiv în zonele expuse la umiditate sau variații de temperatură, fără teama de a-și pierde aspectul sau structura.

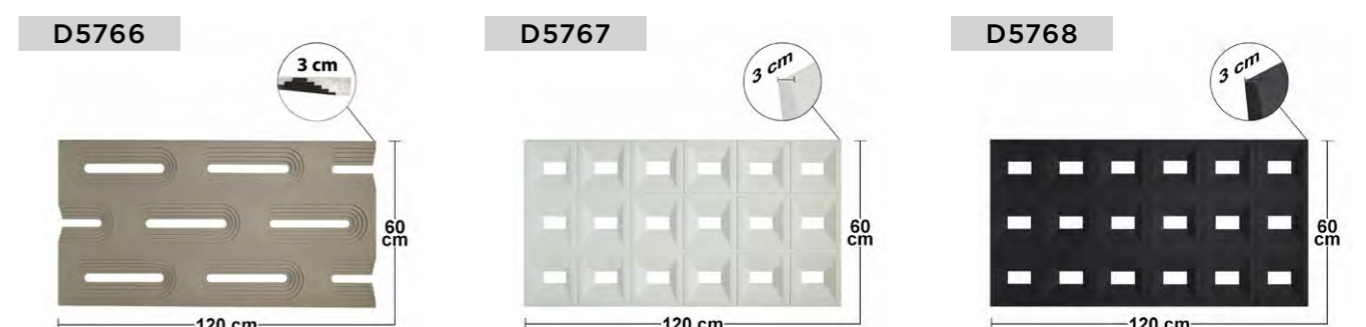
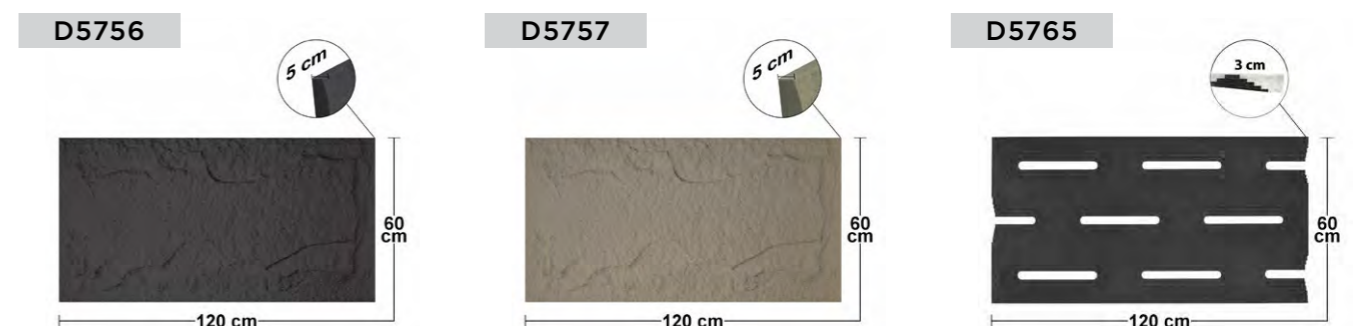
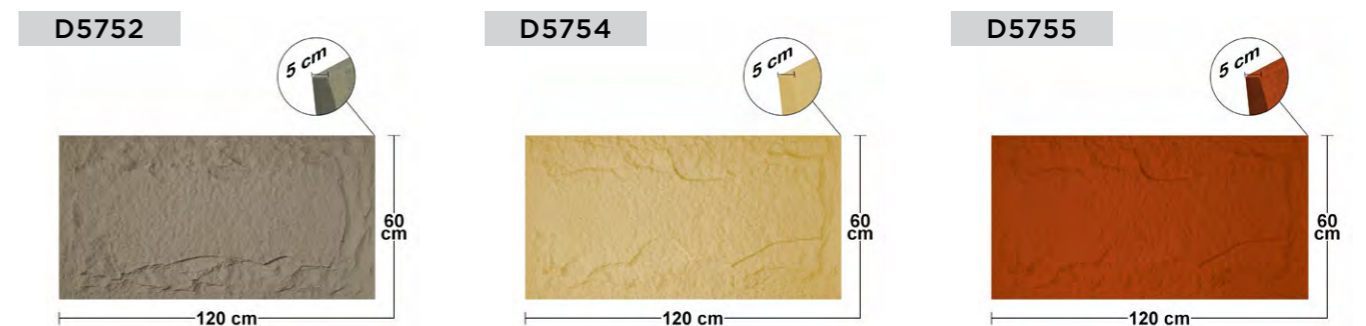
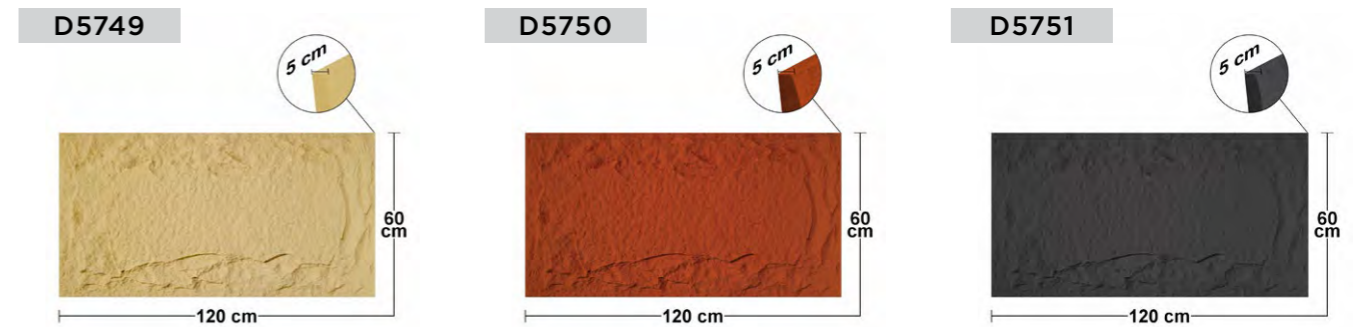
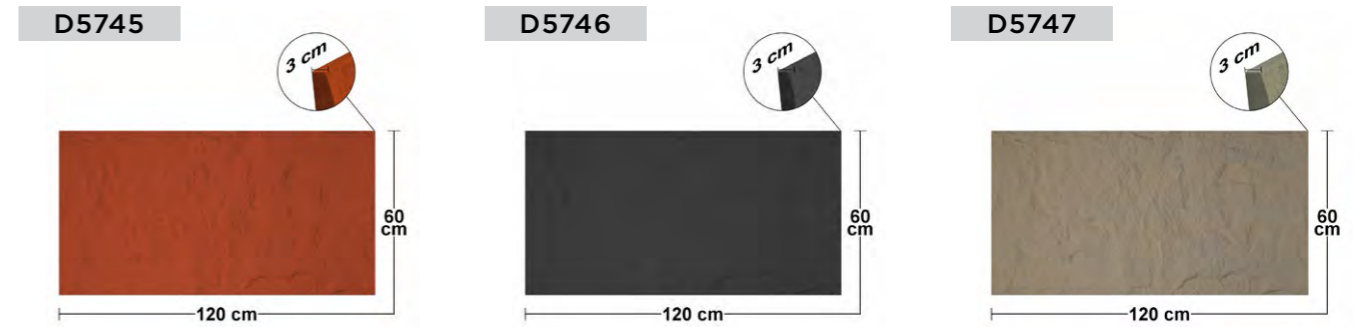

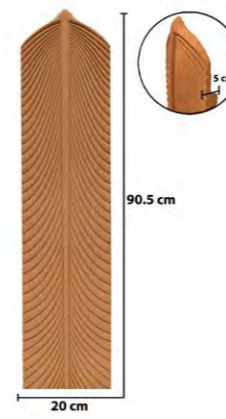
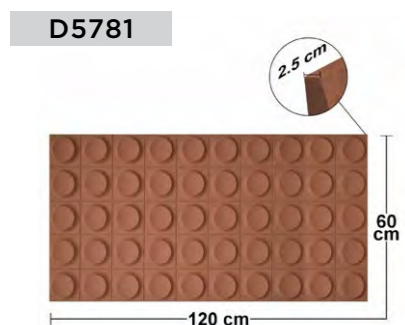
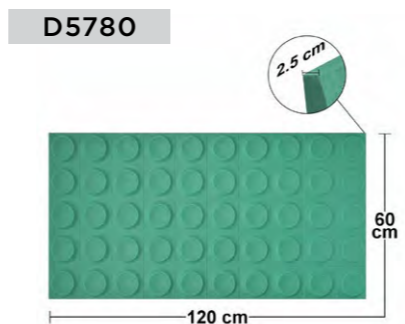
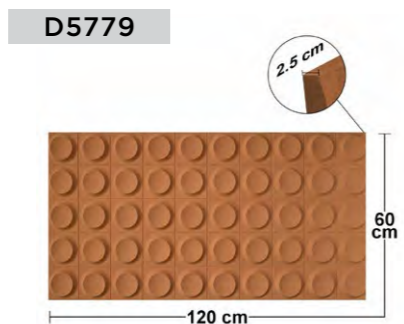
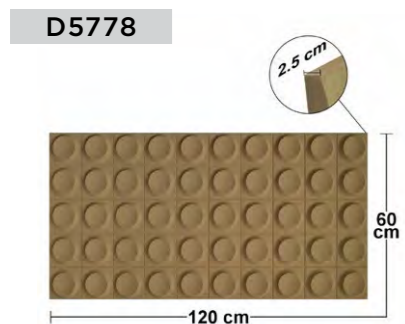
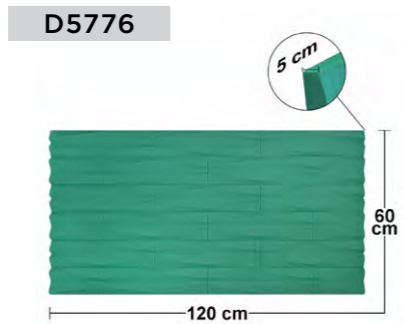
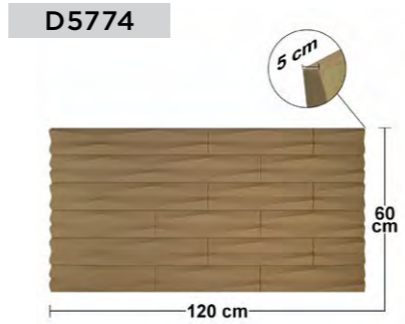
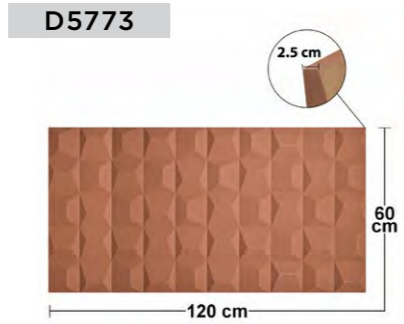
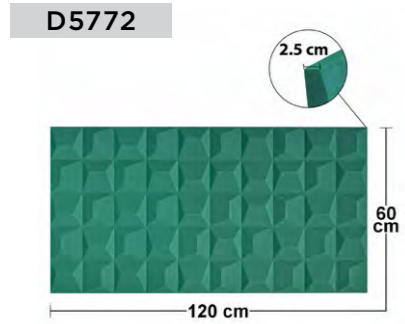
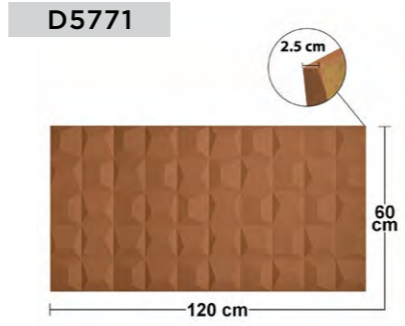
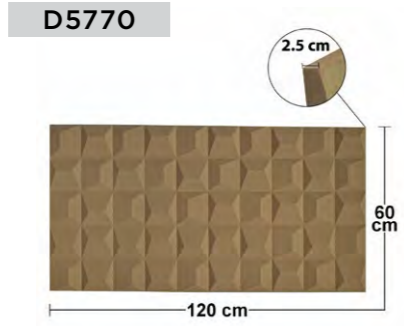
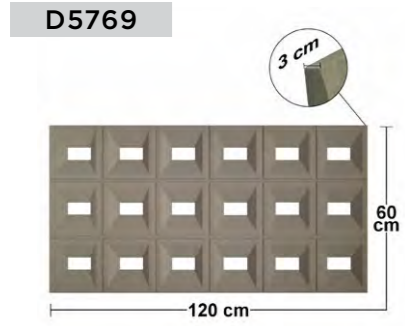

D5783

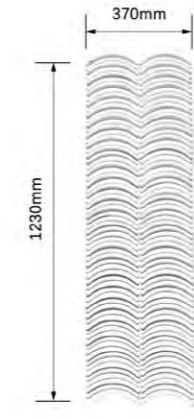

D7567

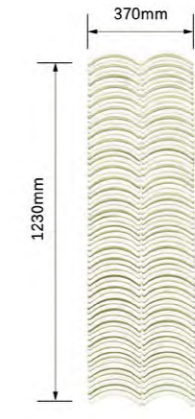

D7568

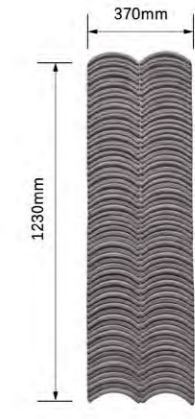

D7569

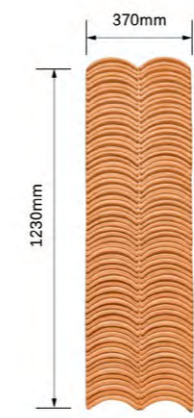

D7570

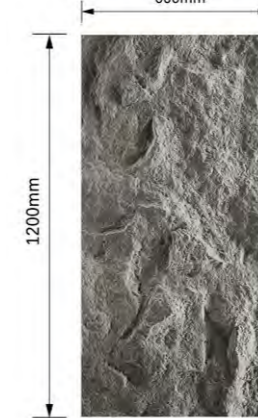

D7584



D7586

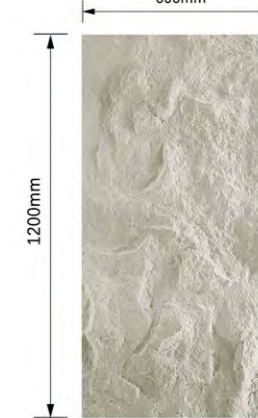

D7587



D7588



D7589



D7590



D7591



D7592



D7593



D7594

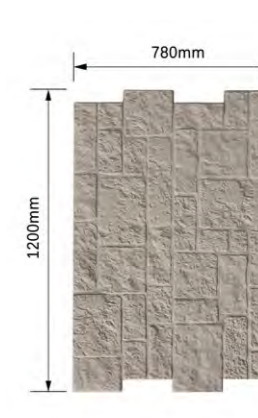

D7595

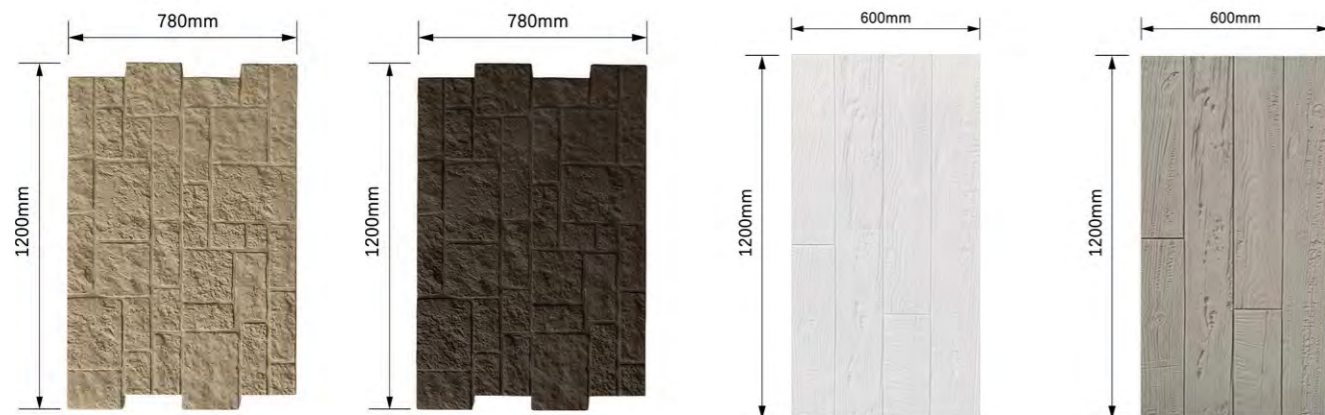

D7596

D7597

D7602

D7603



D7604

D7605

D7606

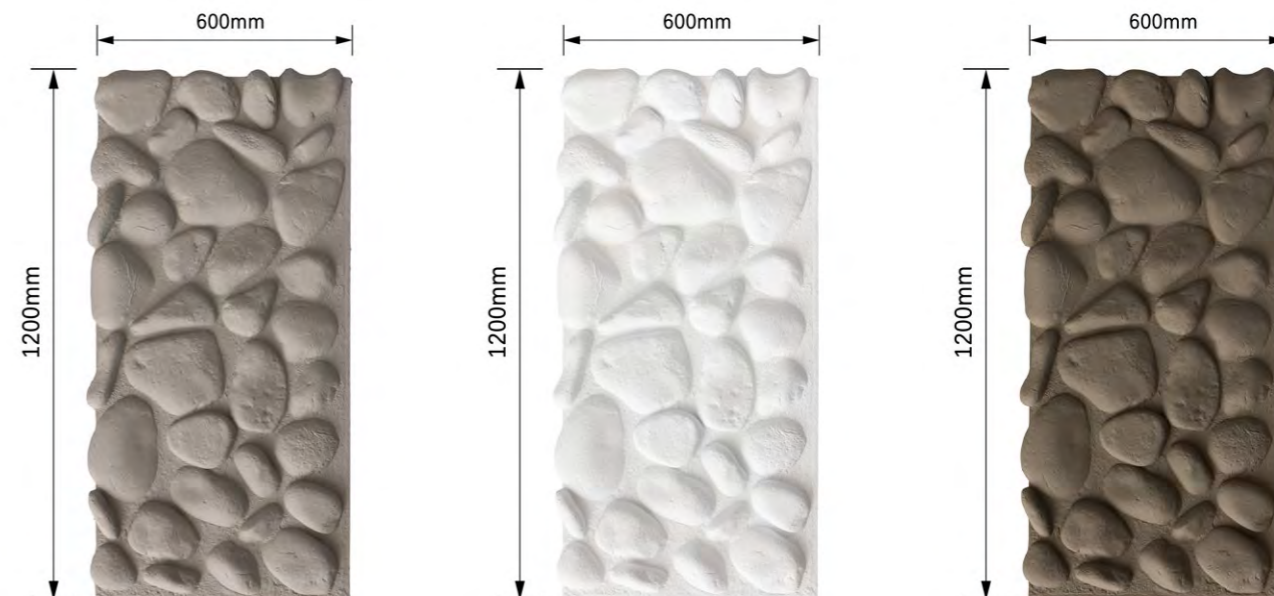

D7575

D7576

D7577

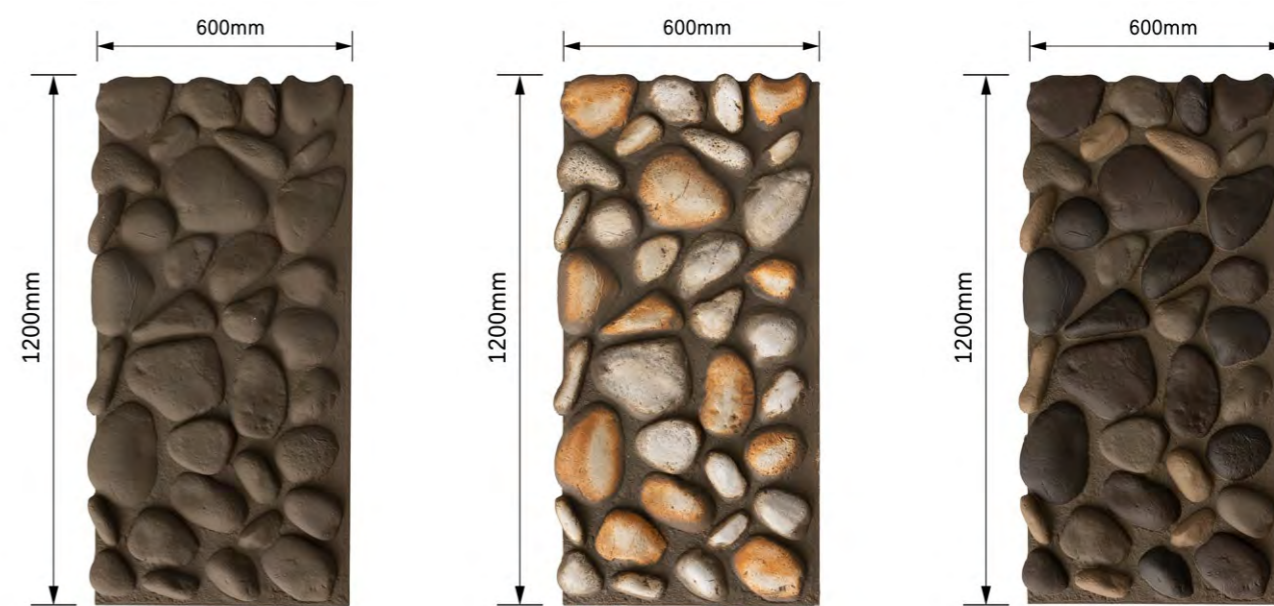

D7578

D7579

D7580

Panourile decorative 3D din PU cu efect de piatră sunt concepute și fabricate cu mare atenție la detalii, redând fidel aspectul și textura pietrei naturale. Dispunerea aleatorie a pietrelor și efectul de piatră spartă accentuează profunzimea, dimensiunea tridimensională și frumusețea naturală a peretelui. Panourile sunt versatile, fiind ideale pentru utilizare la interior dar și pentru decorarea pereților exteriori, adăugând un stil unic și un plus de eleganță aspectului general al proprietății.

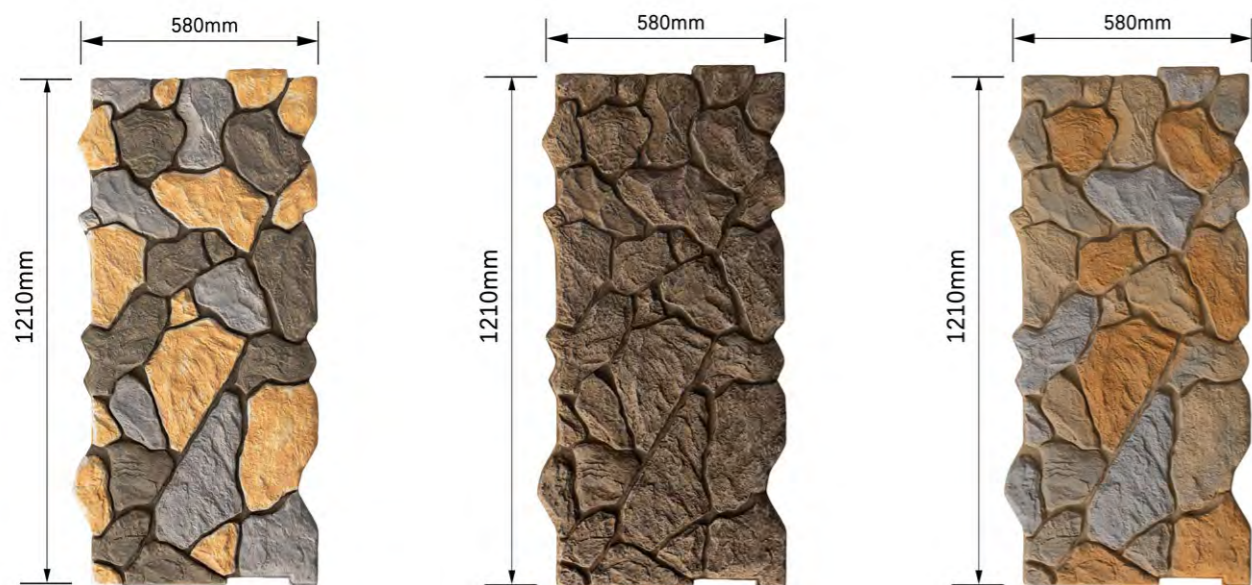

D7572

D7573

D7574



D7581

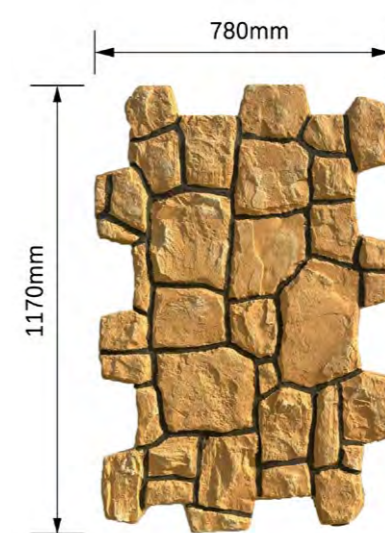

D7582

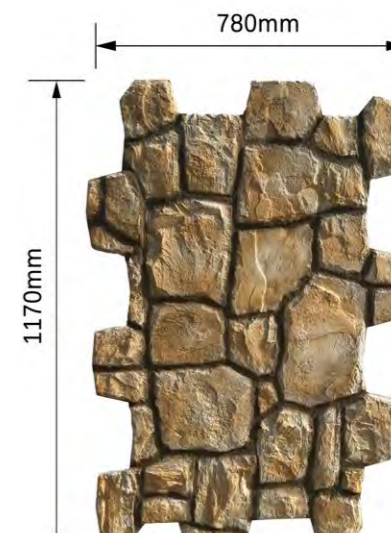

D7583

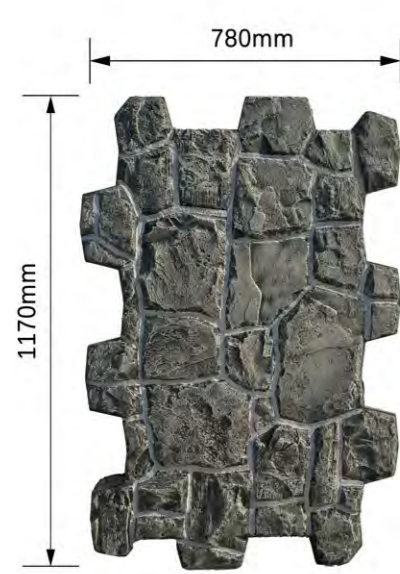

D7584

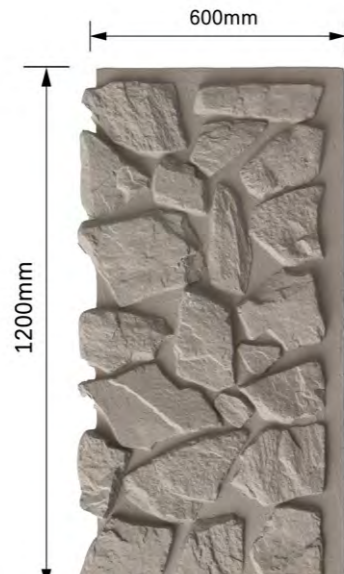

D7598



D7599

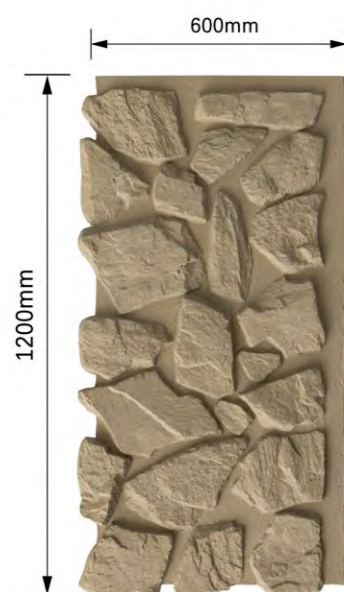

D7600



D7601

VOPSEA PROTECTIVĂ

STRAT EVA ELASTIC

FINISAJ INTEGRAT PRIN MATRICE

PU DE DENSITATE RIDICATĂ

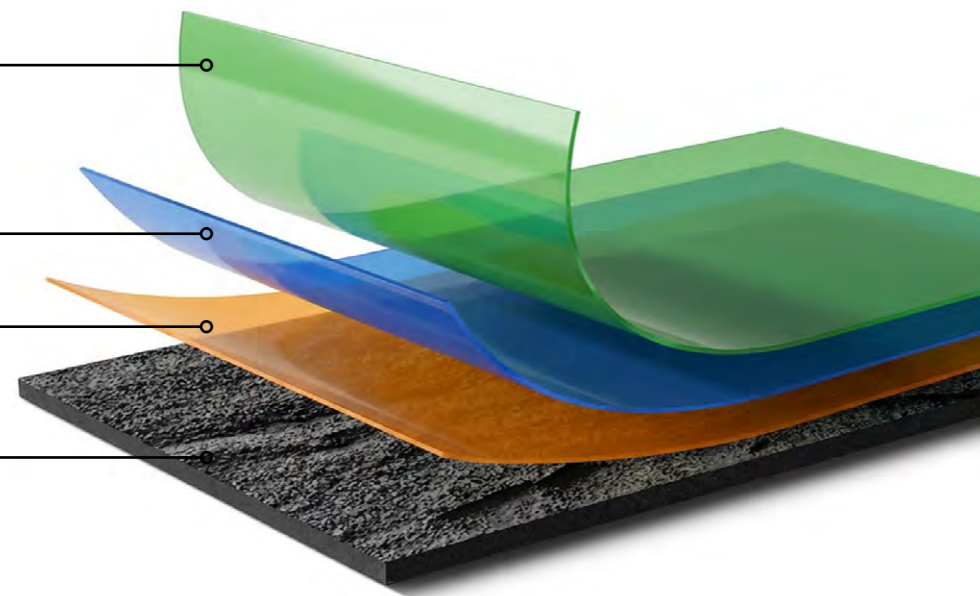

Panouri acustice

Panourile acustice decorative de la Decoran, realizate din MDF robust și strat de pâslă, reprezintă soluția ideală pentru controlul acustic și decorarea spațiilor. Materialul de înaltă calitate, cum este MDF-ul, oferă durabilitate pe termen lung, iar designul modern le face ideale pentru orice tip de spațiu, fie că este un birou, un studio de înregistrare sau o locuință.

Aceste panouri acustice sunt potrivite și pentru spații comerciale, săli de conferințe sau chiar spații de locuit unde se dorește o îmbunătățire a acusticii și reducerea zgomotului.

Instalarea panourilor acustice este rapidă și simplă, putând fi montate folosind adezivi sau sisteme de prindere fără a necesita unelte specializate. Panourile de izolare fonică sunt flexibile, ajustabile și se potrivesc pentru orice tip de perete sau tavan, oferind atât funcționalitate, cât și un design decorativ elegant. Aceste panouri acustice MDF sunt testate și certificate pentru atenuarea sunetului, conform standardelor internaționale, oferind o soluție de izolare fonică eficientă.

Disponibile într-o varietate de dimensiuni și modele, panourile acustice MDF și panourile decorative cu izolare fonică sunt ideale pentru spații care necesită îmbunătățirea acusticii.

Dacă ești în căutarea unui panou acustic decorativ, unui panou de izolare fonică sau unui panou pentru perete cu funcții acustice, Decoran îți oferă produse de înaltă performanță, ușor de instalat și ideale pentru controlul zgomotului.



D6232

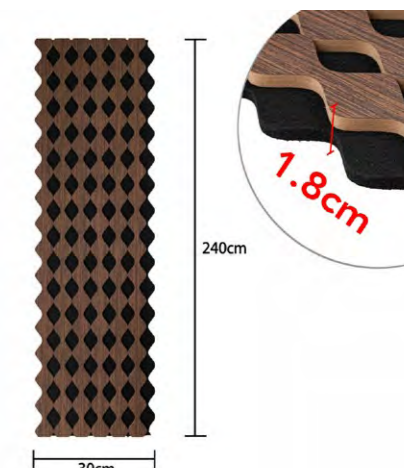
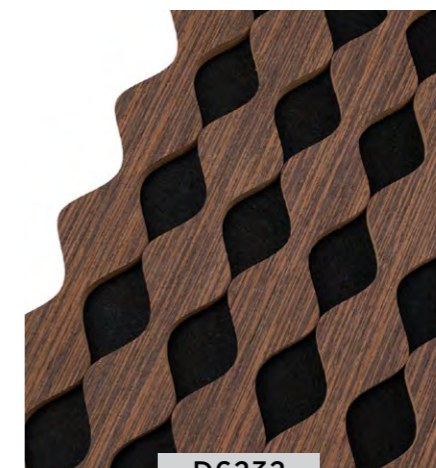

D6233

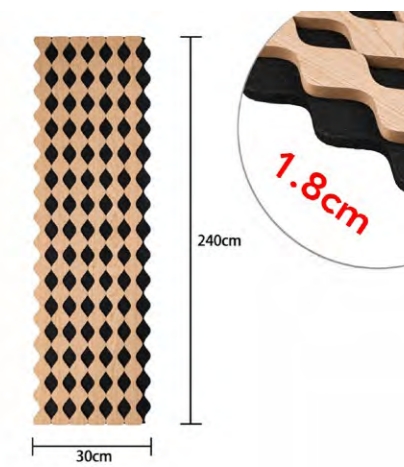



D6234

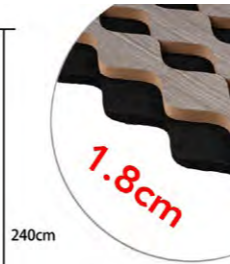

240cm

30cm

1.8cm



D6242



240cm

30cm

1.8cm

3cm

2cm

x3



D6238



240cm

30cm

1.8cm

x3



D6243



240cm

30cm

1.8cm

3cm

2cm

x3



D6240

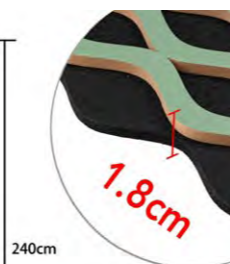

240cm

30cm

1.8cm

5cm

2cm

x3



D6244

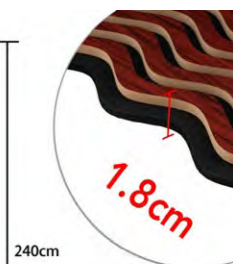

240cm

30cm

1.8cm

1.2cm

2cm

x3



D6241



240cm

30cm

1.8cm

3cm

2cm

x3



D6245

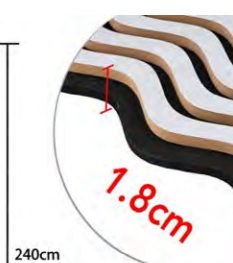

240cm

30cm

1.8cm

1.2cm

2cm

x3

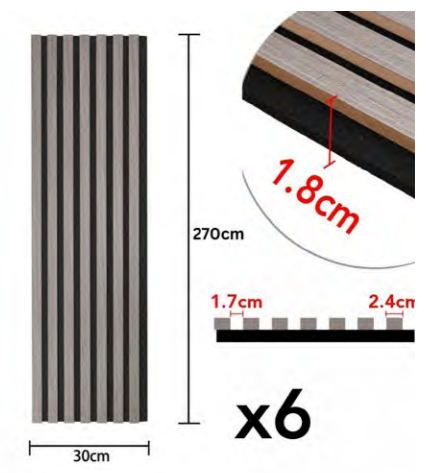
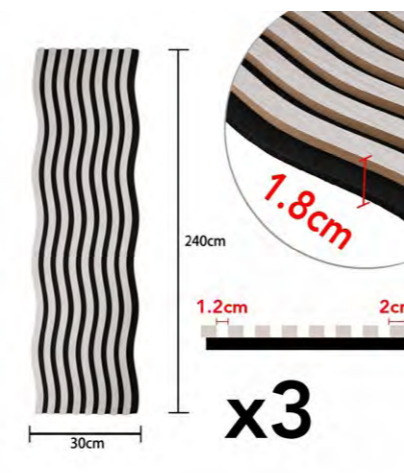
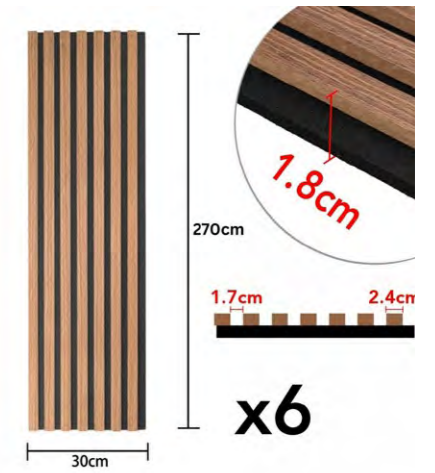
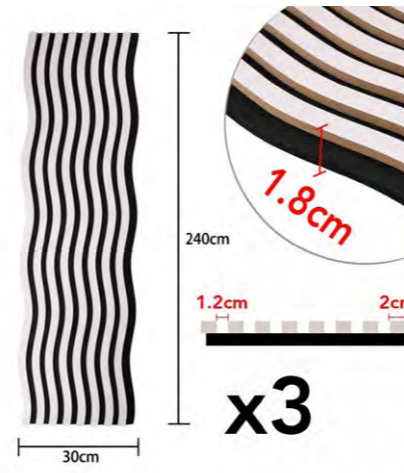
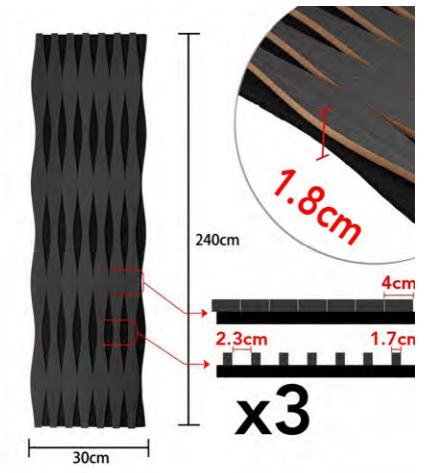
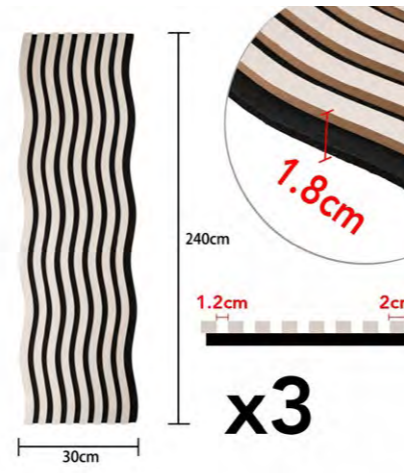
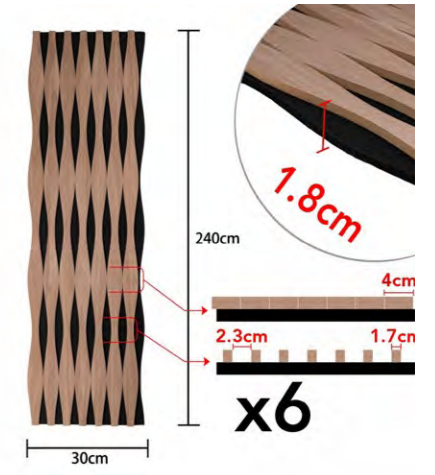
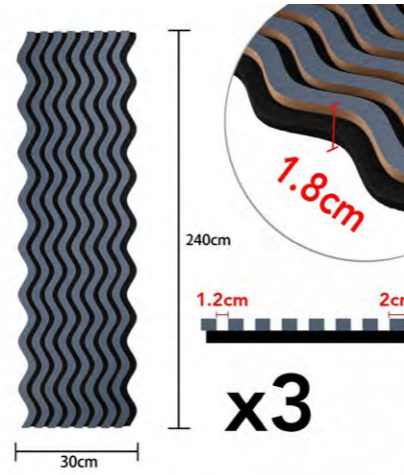

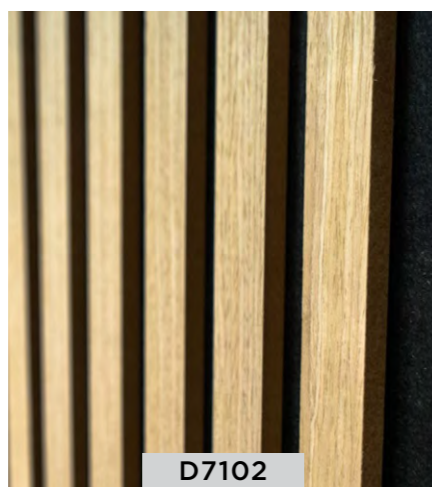
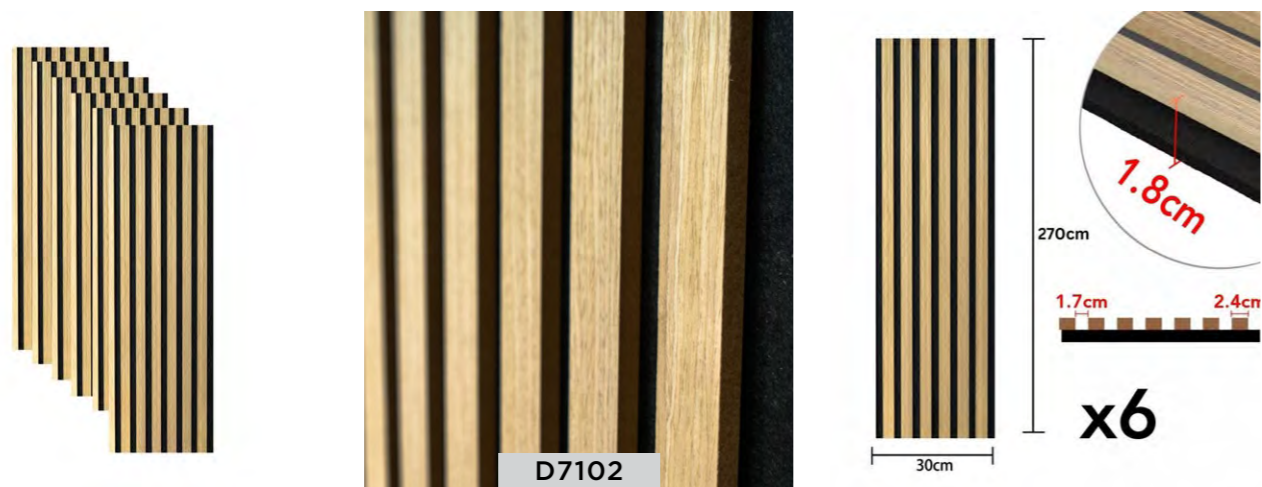

D7102

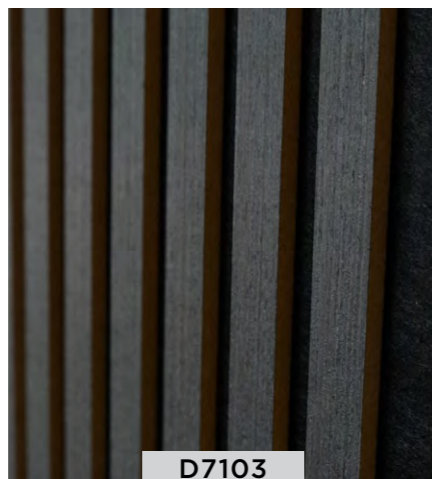

D7103

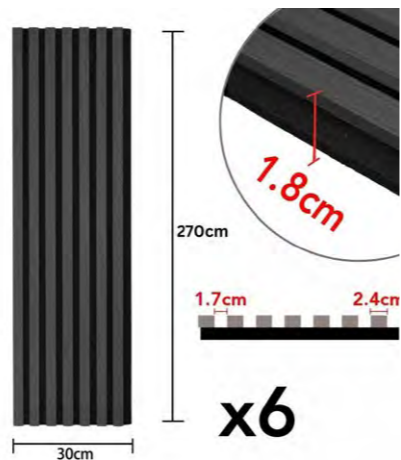

1. Materialul de baza - MDF

MDF-ul este un material durabil și versatil, format din fibre lemnoase presate sub presiune și căldură, oferind o structură densă și uniformă. Panourile din MDF sunt solide și au proprietăți bune de izolare fonică, ajutând la diminuarea zgomotelor reflectate. Grosimea de 12 mm asigură rigiditate, păstrând totodată o greutate redusă, ceea ce le face ușor de montat pe pereți sau tavan.

2. Stratul de pâslă

Pâsla este un material textil dens, cunoscut pentru capacitatea sa de absorbție a sunetului. Stratul de pâslă de 9 mm amplasat peste MDF adaugă o barieră suplimentară pentru sunet, contribuind la absorbția și disiparea zgomotului de frecvențe medii și înalte. Pâsla conferă și un aspect estetic plăcut, fiind disponibilă în diferite culori și texturi.

3. Dimensiuni și utilizare

Panourile au dimensiuni compacte și ușor de integrat în diverse spații interioare. Sunt ideale pentru birouri, săli de conferințe, studiouri de înregistrări sau spații rezidențiale unde este necesară îmbunătățirea acusticii. Pot fi montate individual sau aranjate în configurații mai complexe pentru a acoperi suprafețe mai mari.

4. Avantaje

Reducerea ecorurilor și a zgomotelor ambientale. Montaj ușor datorită dimensiunilor standard. Design versatil, potrivit pentru spații moderne. Durabilitate datorită MDF-ului, care este rezistent la deformări.

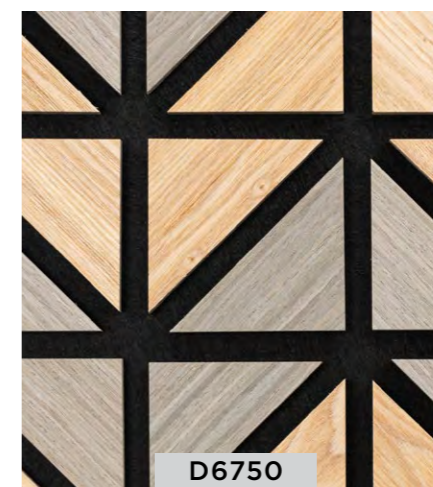

D6750

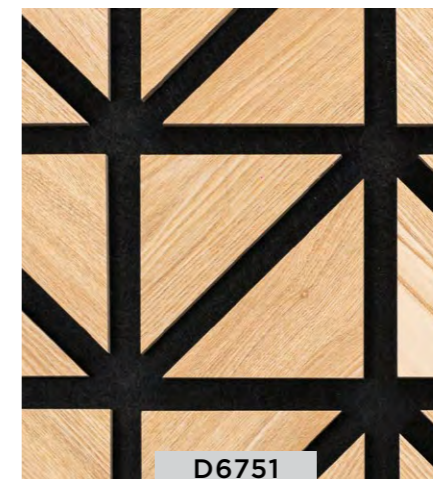
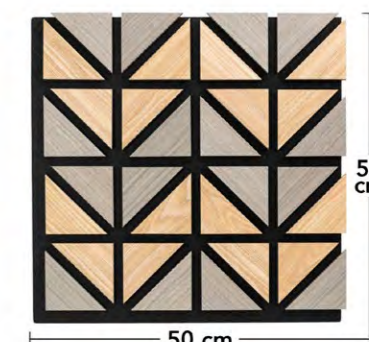

D6751

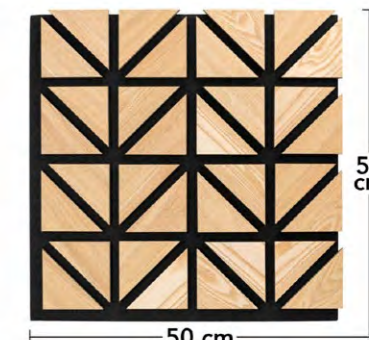

D6752

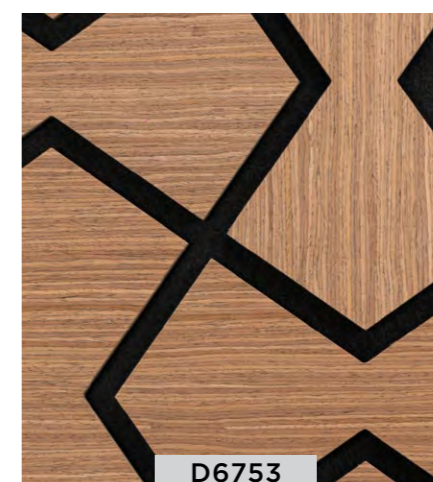
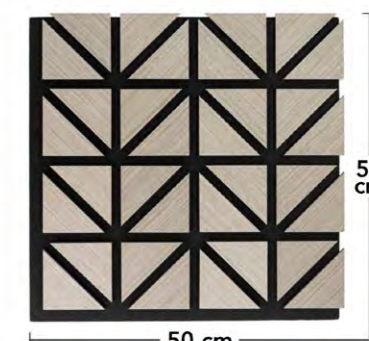

D6753



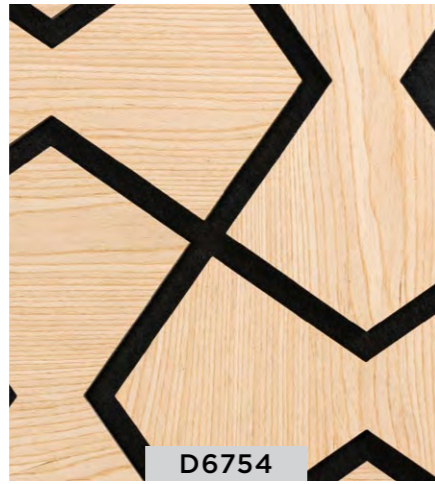

D6754



48 cm

85 cm

1.8cm



D6759

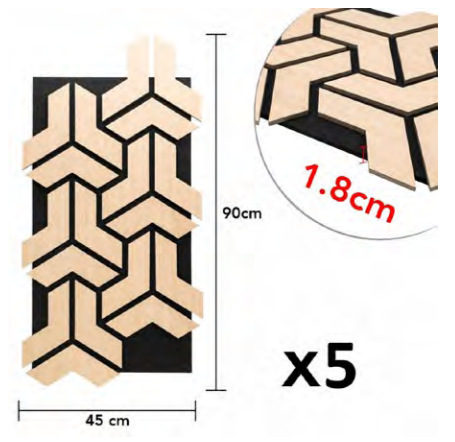

45 cm

90cm

1.8cm

x5



D6756

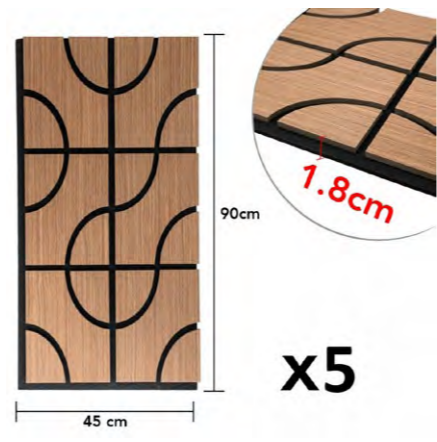

45 cm

90cm

1.8cm

x5



D6760



45 cm

90cm

1.8cm

x5



D6757

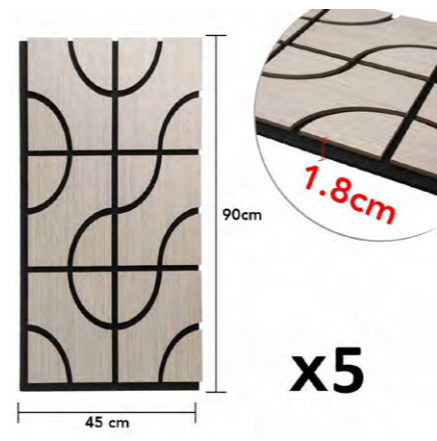

45 cm

90cm

1.8cm

x5



D6762

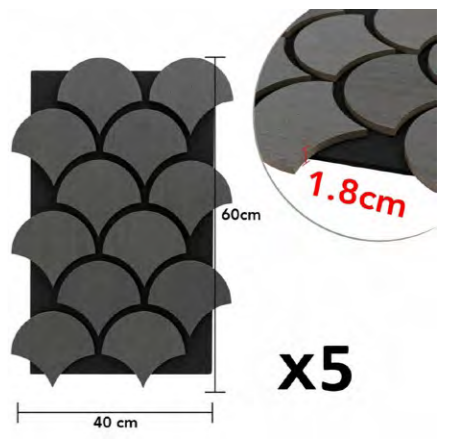

40 cm

60cm

1.8cm

x5



D6758

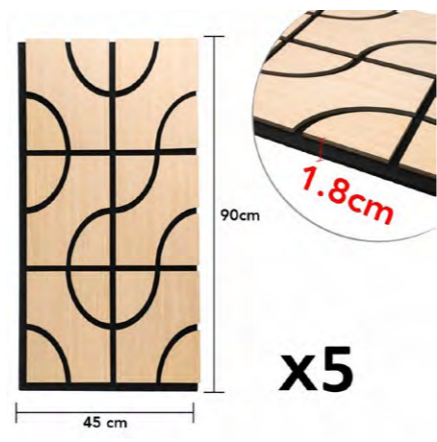

45 cm

90cm

1.8cm

x5

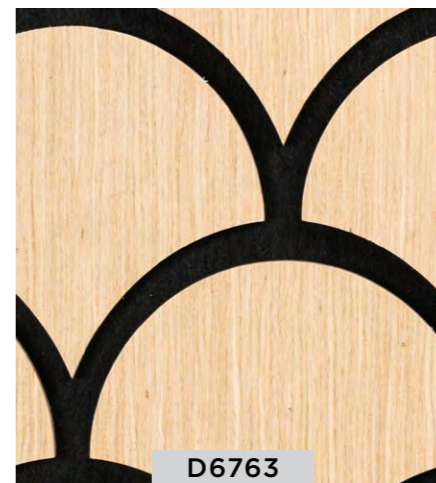

D6763

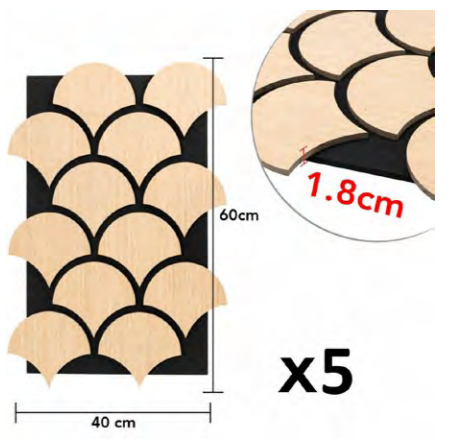

40 cm

60cm

1.8cm

x5

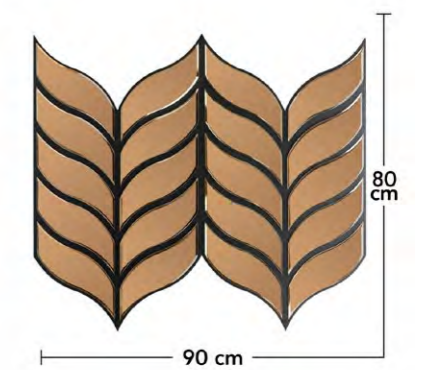
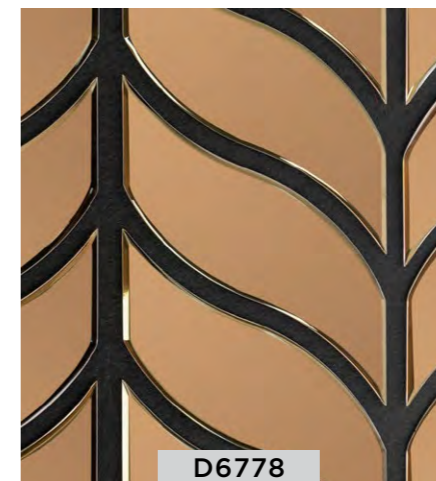
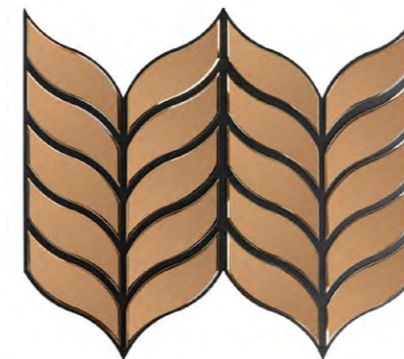
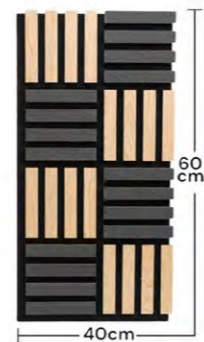
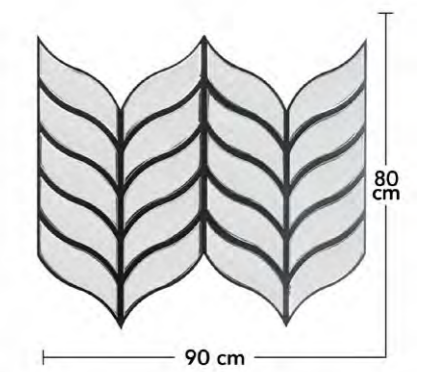
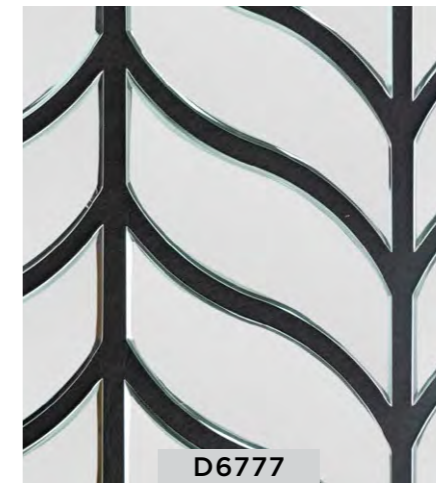
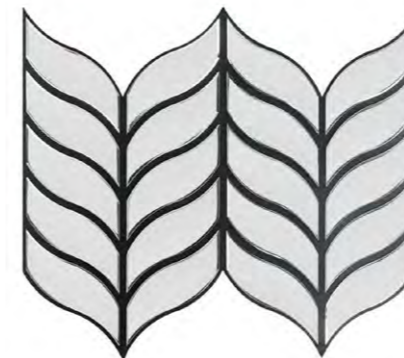
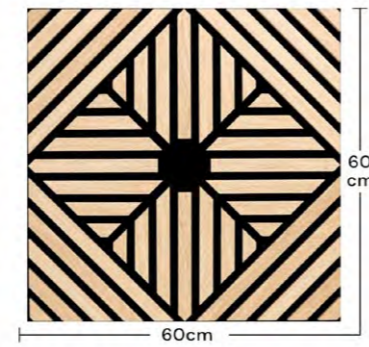
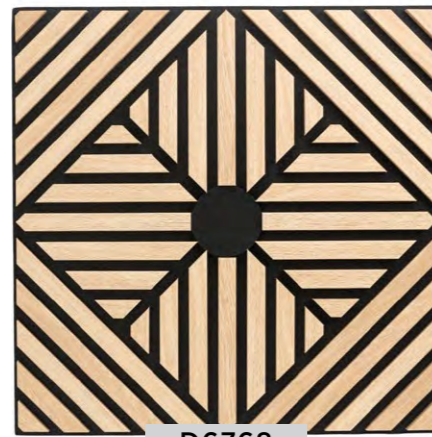
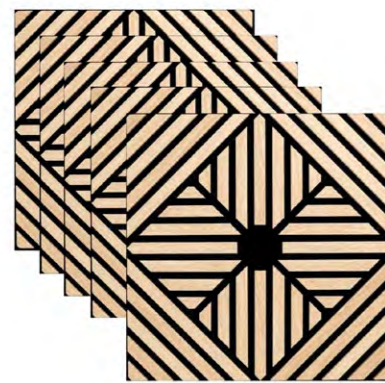
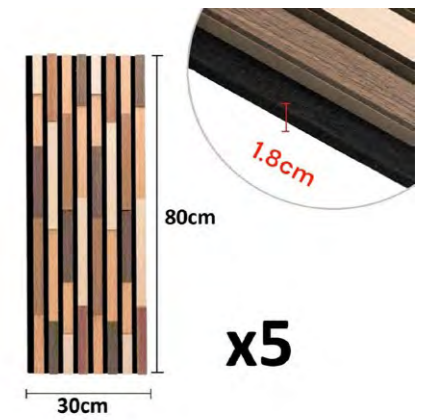
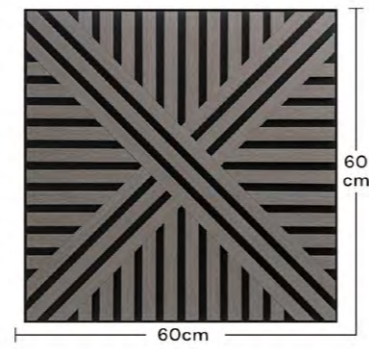
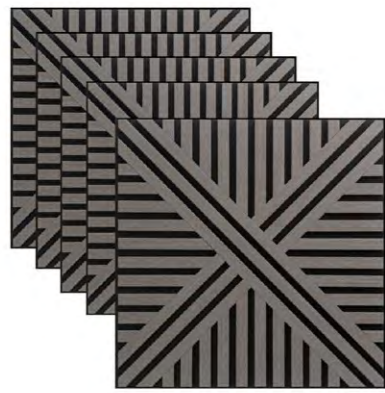
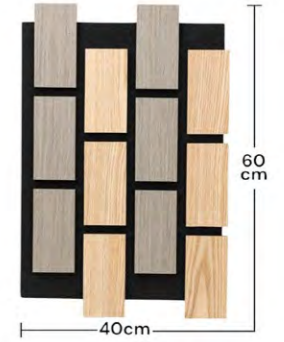

Riflaje

Riflaje flexibile din MDF

Datorită structurii adaptabile și flexibilității ridicate, acest tip de riflaj decorativ se poate monta atât pe suprafețe drepte, cât și curbate, facilitând integrarea în proiecte variate. Designul cu lamele decorative adaugă profunzime și un efect vizual tridimensional, fiind potrivit pentru diverse tipuri de amenajări interioare.

MDF-ul este acoperit la suprafață cu un strat decorativ de tip furnir, care reproduce textura și desenul lemnului natural oferind:

- **Aspect realist de lemn:** nervuri și textură asemănătoare lemnului.
- **Suprafață plăcută la atingere:** imita textura lemnului.
- **Uniformitate de culoare:** fără diferențe ca lemnul masiv
- **Durabilitate ridicată:** rezistent la uzură și ușor de întreținut.

Pe partea din spate, panoul este prevăzut cu un strat textil de susținere, care contribuie la stabilitate și asigură o flexibilitate sporită pentru montaj facil inclusiv pe suprafețe curbate.

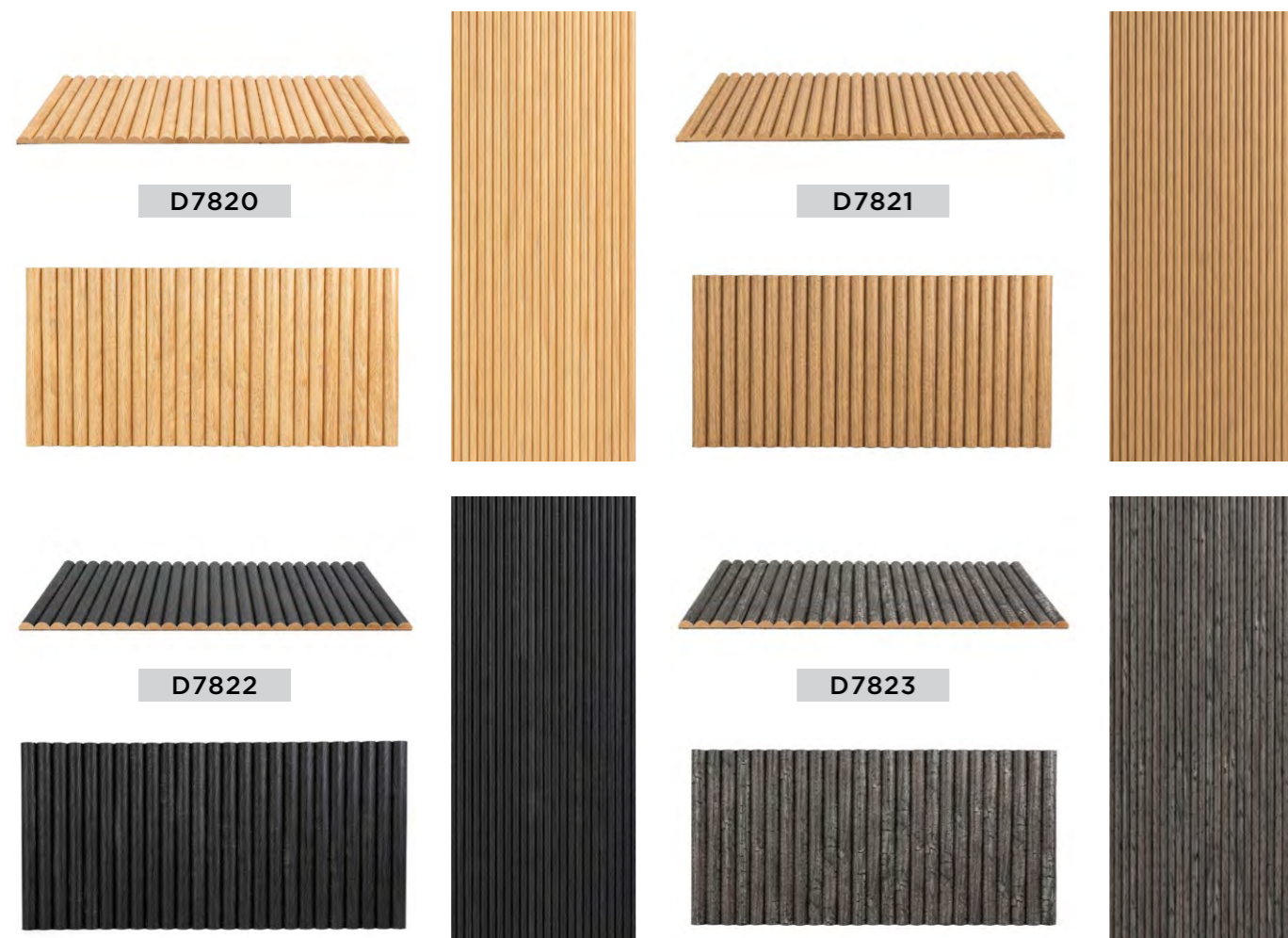



D7832

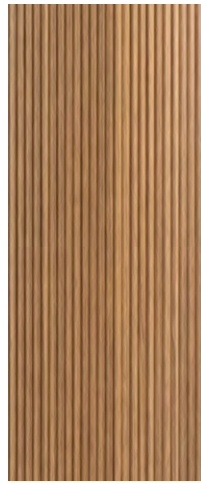

D7833



D7840

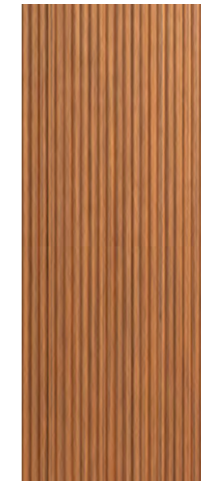

D7841



D7834



D7835



D7842



D7843



D7836



D7837



D7844



D845



D7838



D7839



D7846



D7847





**IDEAL
PENTRU
SUPRAFEȚE
CURBE**



Riflaje rigide din polimer

Descoperă la Decoran panouri riflaj decorative din polimer rigid, perfecte pentru a transforma orice spațiu într-unul modern și sofisticat.

Alege dintre riflaj alb, culoarea lemnului sau alte nuanțe, ideale pentru pereți despărțitori și decoruri interioare elegante.

Riflajele noastre sunt soluții versatile, adaptabile oricărui tip de amenajare interioară, oferind un plus de stil și funcționalitate. Vezi colecția noastră de riflaj decorative și creează un design unic în locuința ta!



D5461



D5462

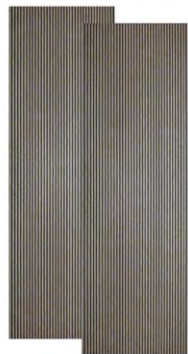

D5463

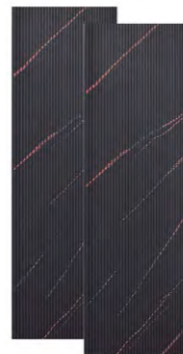

D5464

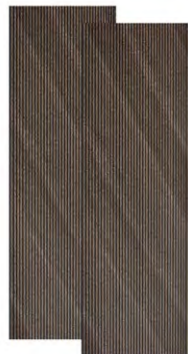

D5465



D5466



D5467



D5468

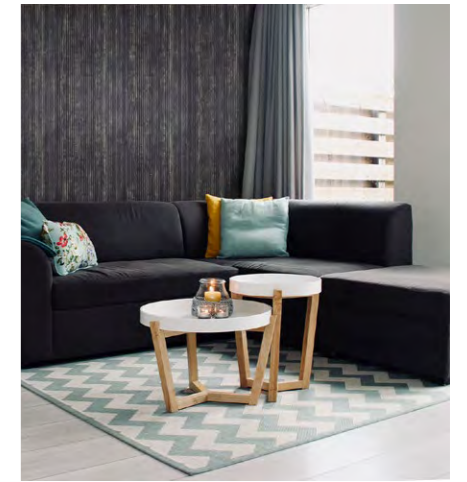

D5469



D5470



D5471

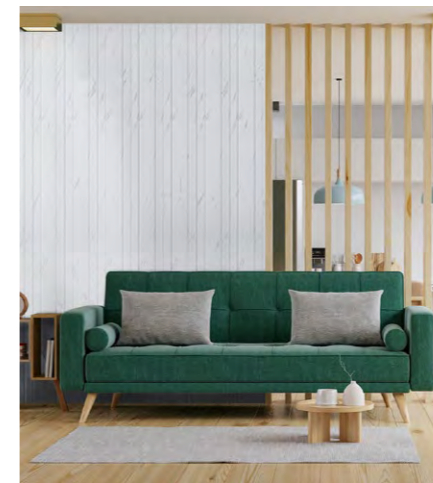

D5472

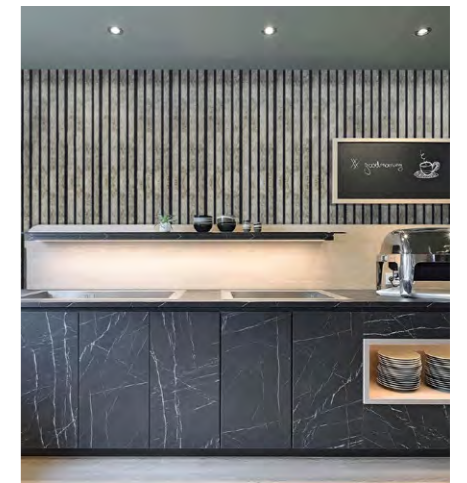

D5473



D5474





D5475



D5476



D5477



D5478



D5483

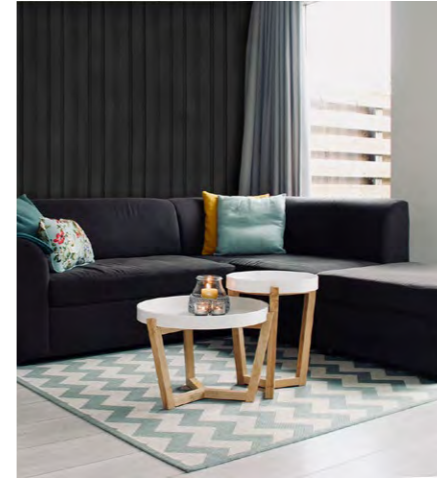

D5484



D5479



D5480



D5485

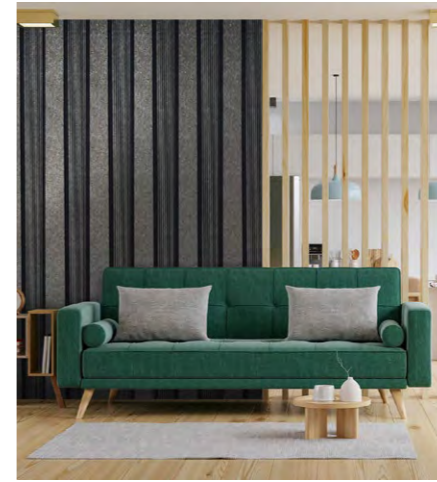

D5486



D5481



D5482



D5487



D5788



D5489



D5490





D5491

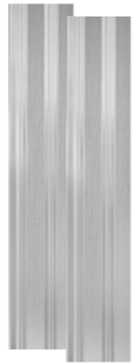
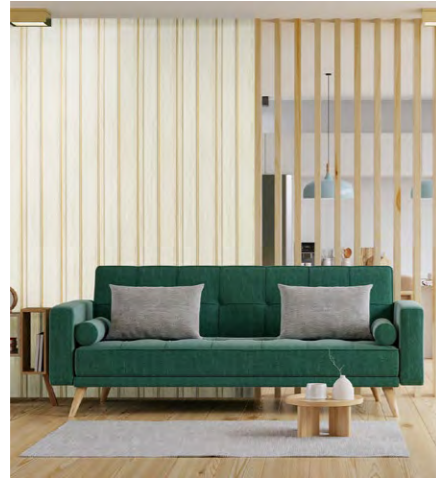

D5492



D5499



D5500



D5493



D5494



D5501



D5502

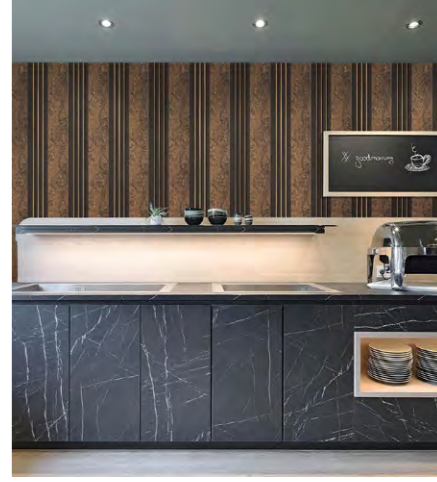

D5495

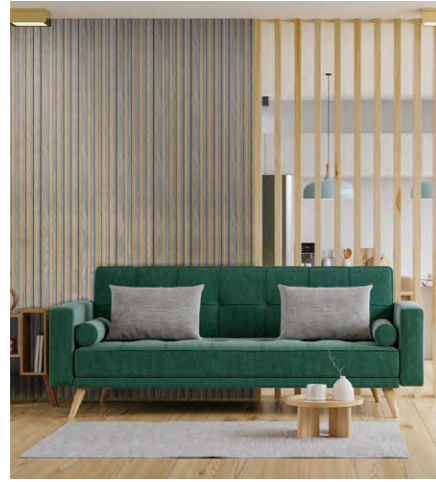

D5496

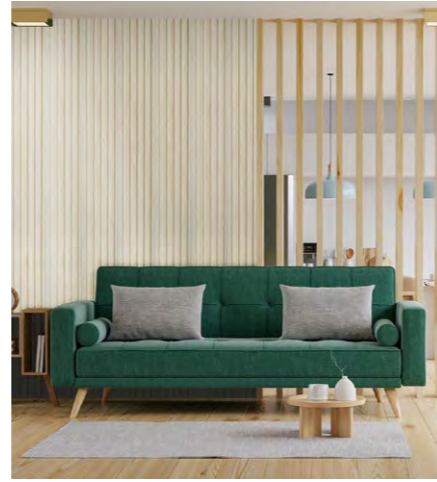

D5503



D5504



D5497



D5498



D5507



D5508





Plante Artificiale

Perfecte pentru terase, balcoane, curți și verande, panourile cu plante artificiale și flori artificiale de la Decoran oferă intimitate și un aspect natural deosebit, atât pentru interior, cât și pentru exterior. Aceste panouri verzi artificiale, realizate din materiale plastice durabile, rezistă la uzură și intemperii fără a necesita întreținere specială.

Fie că le folosești pentru a delimita spații, ca paravan verde artificial, plasa gard cu frunze artificiale sau pentru a adăuga un plus de verdeață și eleganță, acestea sunt soluția ideală pentru decoruri moderne și practice. Panourile de verdeață artificială, inclusiv cele cu iederă și iarbă artificială, sunt flexibile, ajustabile și pot fi montate ușor pe orice suprafață, oferind un design modular și versatil care se poate adapta oricărui tip de spațiu.

Aranjamente de perete tip panou, cu ramă

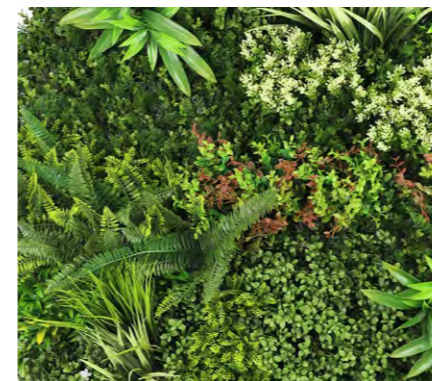

D7463



D7464

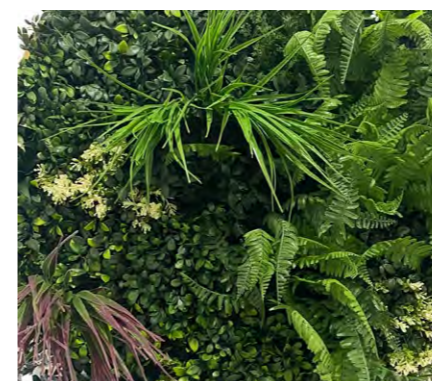

D7465



D7466



D7467

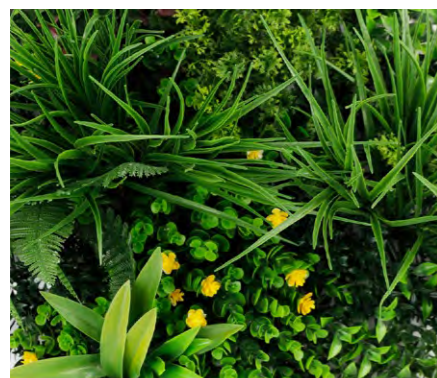

D7468



D7469



Aranjamente florale suspendate

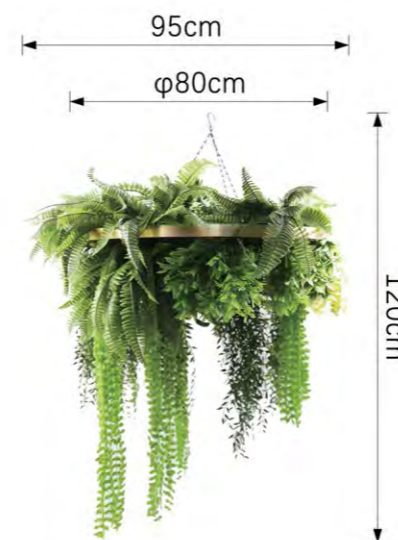

D7444



D7445



D7446

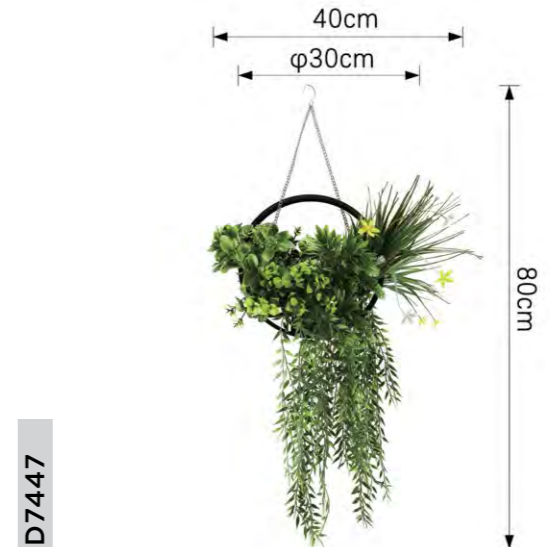

D7447

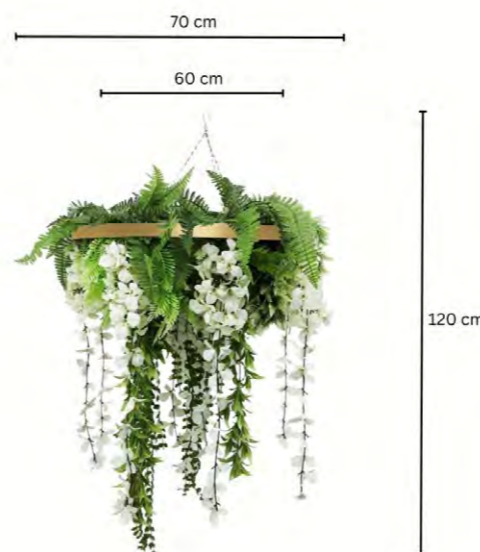

D7454



D7474

D7475



D7476



D7448



D7449



D7450



Panouri din plante ABC

Continuitate naturală



D7431

D7432

D7433

Continuitate naturală



D7434

D7435

D7436

Continuitate naturală



D7437

D7438

D7439



D7431



D7432



D7433



D7434



D7435



D7436



D7437

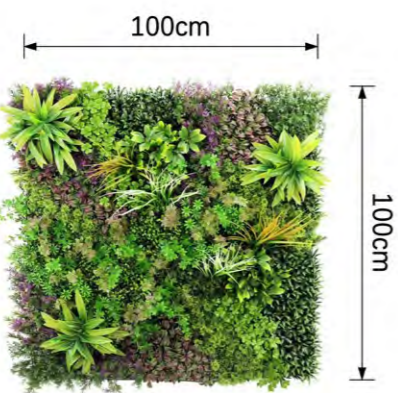

D7438



D7439



Panouri cu flori



60 x 40 cm

D4999



60 x 40 cm

D5000



60 x 40 cm

D5003



60 x 40 cm

D5894

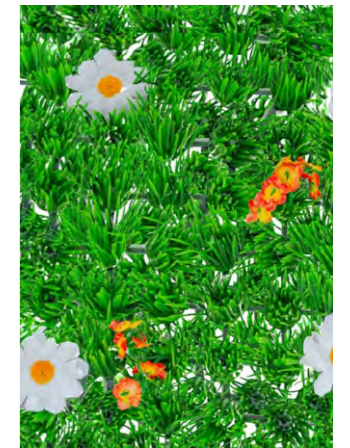

60 x 40 cm

D5898

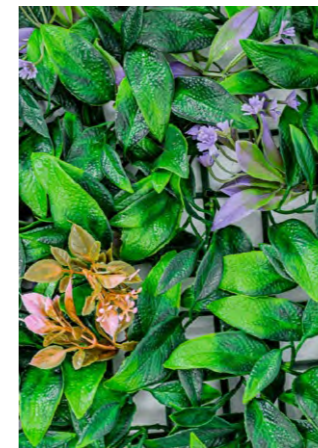

10 x 25 cm

D5905

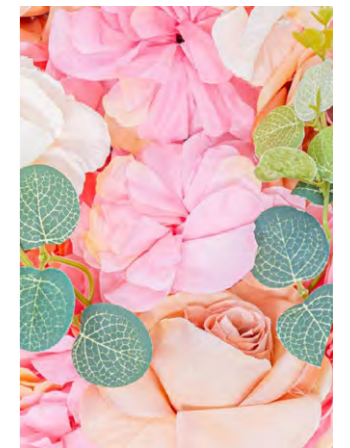

10 x 25 cm

D5906



10 x 25 cm

D5907

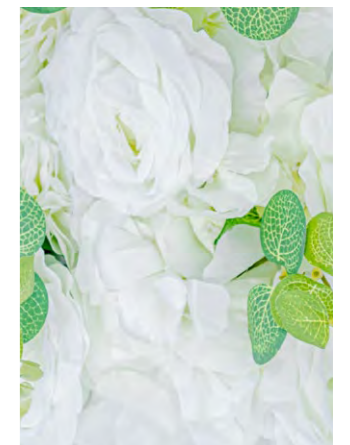



10 x 25 cm

D5908



60 x 40 cm

D5909



60 x 40 cm

D5910



60 x 40 cm

D5911



60 x 40 cm

D5912



50 x 100 cm

D5913

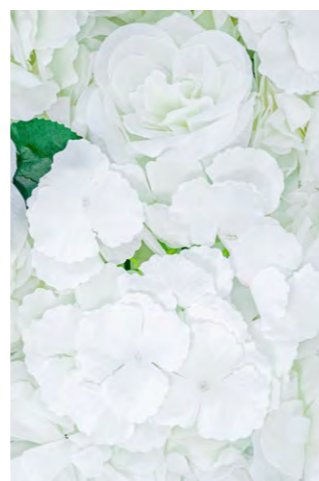

Covoare din mușchi artificial

Panoul decorativ cu mușchi artificial aduce natura în interiorul casei tale, oferind un aspect verde, vibrant și relaxant. Realizat din mușchi artificial pentru a-și păstra textura și culoarea în timp, acest panou nu necesită întreținere, fiind perfect pentru orice spațiu.

Este ideal pentru a crea un punct focal în living, birou sau chiar în spații comerciale, adăugând o notă de prospețime și calm.



100 x 100 cm

D6542



90 x 100 cm

D6543



90 x 100 cm

D6544



90 x 100 cm

D6545



90 x 100 cm

D6546

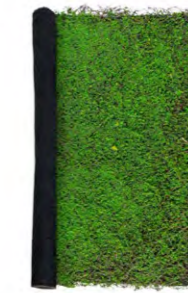

100 x 100 cm

D6551

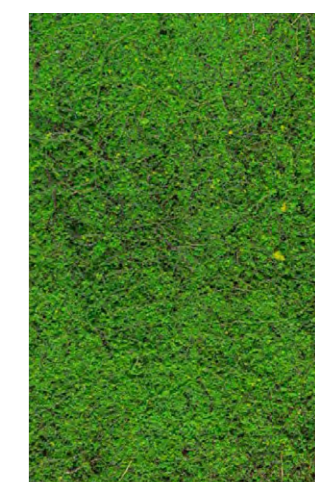

Îmbunătățește-ți decorul cu o gamă diversificată de plante artificiale și elemente decorative, ideale pentru orice spațiu. Colecția noastră include copaci ornamentali și copaci artificiali decorativi pentru curți și grădini, aducând o notă naturală fără necesitatea întreținerii zilnice. Alege din varietatea de orhidee artificiale, panouri de iarbă artificială și pereți verzi pentru a crea un ambient proaspăt și modern în orice încăpere.

Pentru un decor complet, explorează soluțiile noastre cu licheni artificiali și aranjamente în ghivece la prețuri accesibile, ideale pentru interioare și exterioare. De la accente de verdețură naturală până la aranjamente decorative elegante, plantele noastre artificiale sunt gândite pentru a transforma orice spațiu într-un loc plin de vitalitate. Vezi colecția de plante artificiale și alege elementele potrivite pentru un decor de durată, fără grija întreținerii!

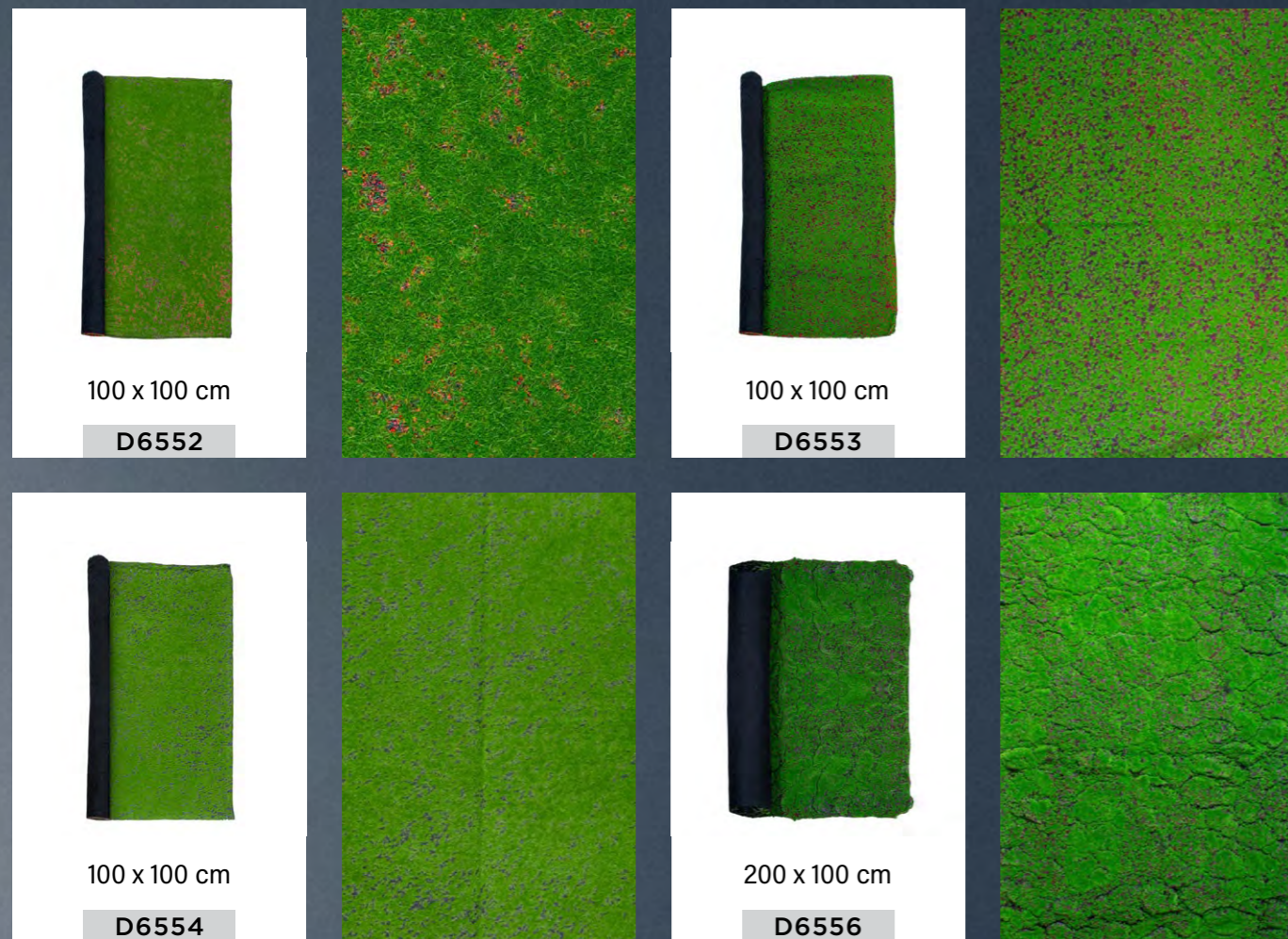

Imitații de gard viu

Construite pe o structură metalică robustă, reprezintă soluția ideală pentru obținerea unui efect verde imediat. O alternativă realistă la gardul viu natural, acest model este complet independent și gata de utilizare, oferind o modalitate rapidă și elegantă de a crea un paravan decorativ verde, potrivit pentru orice spațiu exterior sau interior.

Datorită greutatei reduse și mobilității crescute, gardurile pot fi integrate cu ușurință în diverse amenajări exterioare, oferind intimitate, delimitări vizuale elegante pentru terase sau deck-uri, precum și separări discrete între diferite zone. Reprezintă o soluție rapidă pentru a adăuga un plus de verdeață și rafinament oricărui spațiu. Sunt potrivite atât pentru interior, cât și pentru exterior, fiind ideale pentru locuințe, grădini, birouri, magazine, cafenele, restaurante sau evenimente.

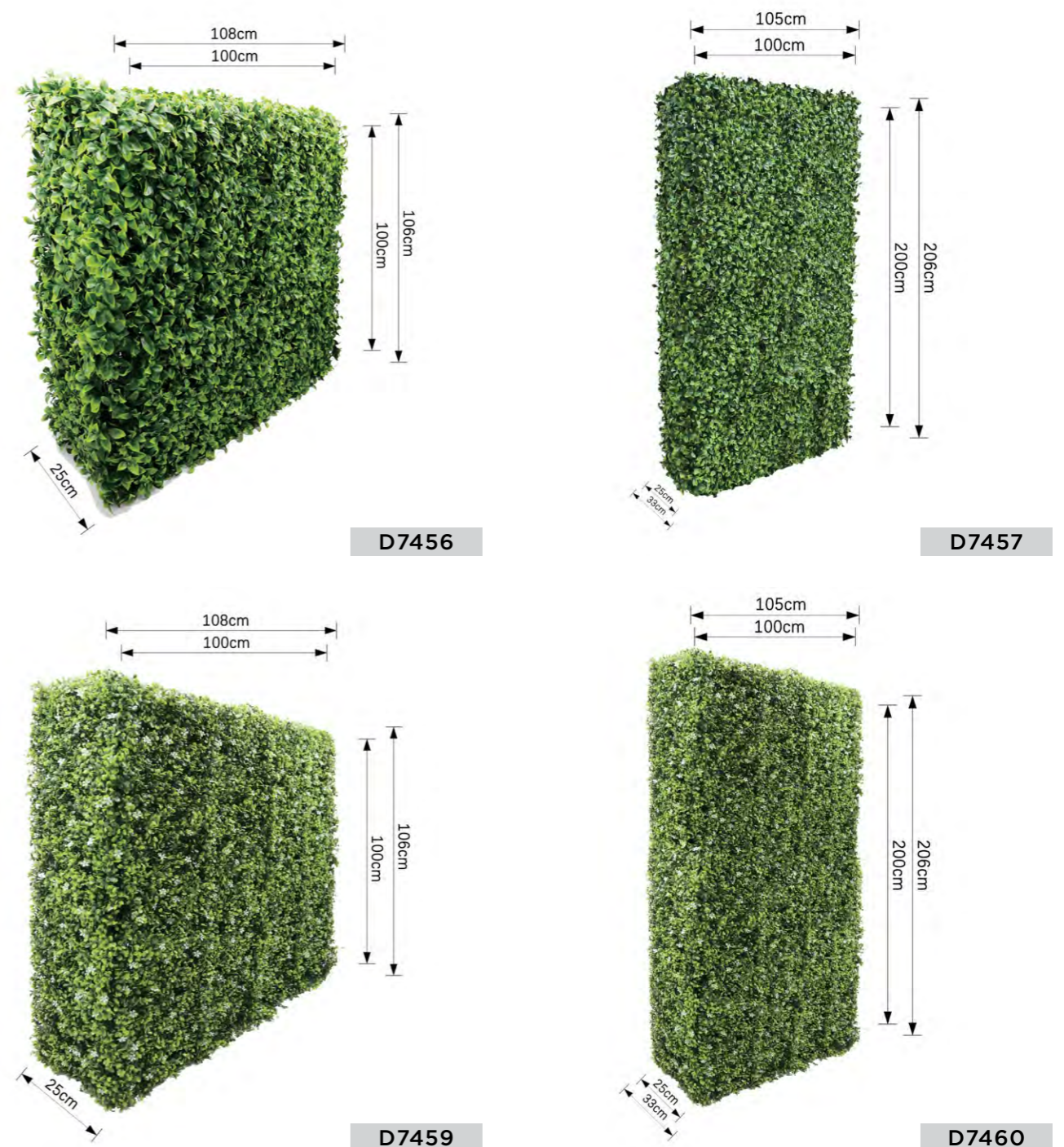



D7455

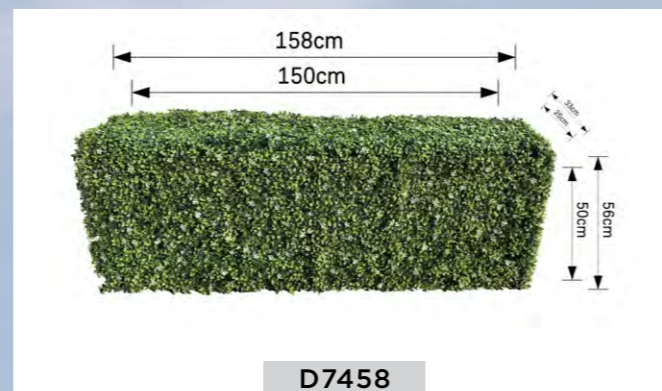

D7458

Structură independentă și ușor de relocat • Foliaj premium, cu aspect natural
 Rezistență ridicată la UV • Design extrem de realist • Cadru metallic solid, dar ușor de manipulat
 Durabilitate crescută • Reutilizabil și versatil • Efect vizual imediat
 Potrivit pentru interior și exterior • Fără întreținere specială • Curățare rapidă



Plasa de gard

Gardul verde cu frunze artificiale pe suport din plastic este o soluție pentru protecția vizuală și decorarea spațiilor interioare și exterioare..

Exterior - pentru decorul, camuflajul sau păstrarea intimității vizuale private (gard de grădină sau curte, mascare pereți exteriori, terasă, gard despărțitor, balcoane, pergole, verande, coloane) etc. Interior - pentru decorul și creșterea valorii vizuale a spațiilor sau paravan pentru pereții despărțitori.

Se montează ușor pe suport metalic, grilaj, plasă metalică, balcon sau gard metalic, cu ajutorul colierelor din nylon. Pe suport de lemn sau zidărie se montează cu dibluri și holzuruburi. Sunt confecționate din material plastic PE de înaltă calitate și durabil, cu protecție UV. Nu necesită întreținere și îngrijire deosebită. Cele montate în exterior se pot spăla cu jet slab de apă iar dacă sunt montate în interior atunci se pot aspira și șterge cu o lavetă moale, ușor umezită.



D4959



D4960

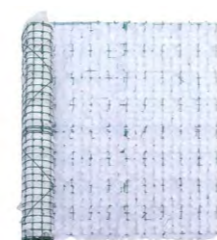
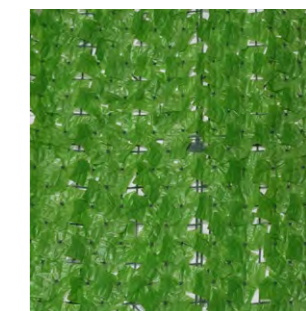

D5960

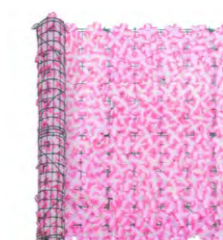
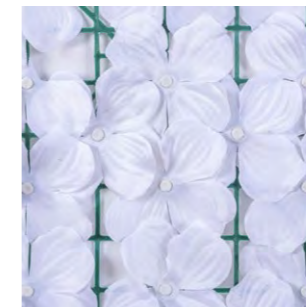

D5961

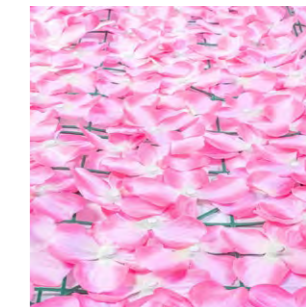

D7218



D5569



D7219



D7220

Plinte din polimer rigid

Sunt confecționate dintr-un polimer rigid de înaltă calitate, care asigură durabilitate și rezistență la uzură. Aceasta alegere a materialului face ca plinta sa fie potrivita pentru utilizarea în zone cu trafic intens. Pot fi fixate cu ușurință folosind un adeziv corespunzător, transformând rapid și ușor orice spațiu.

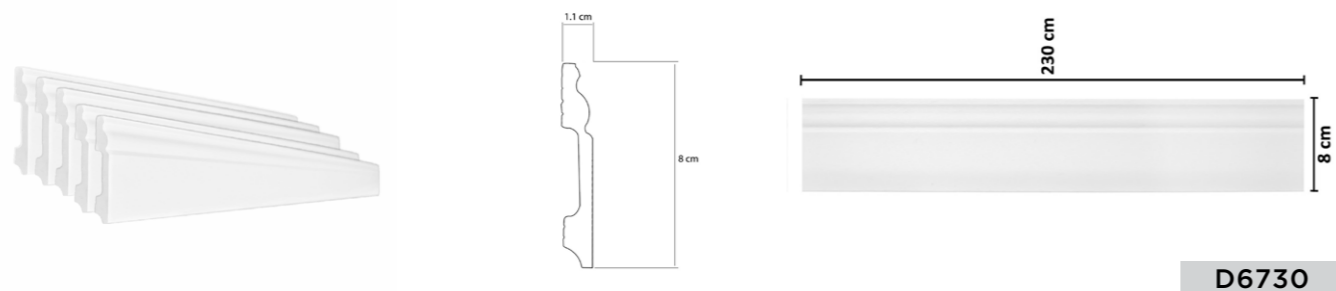

D6730

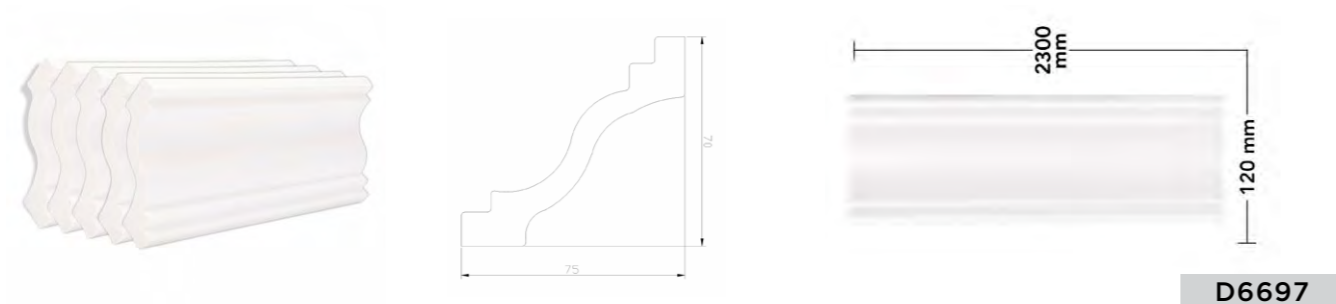

D6697

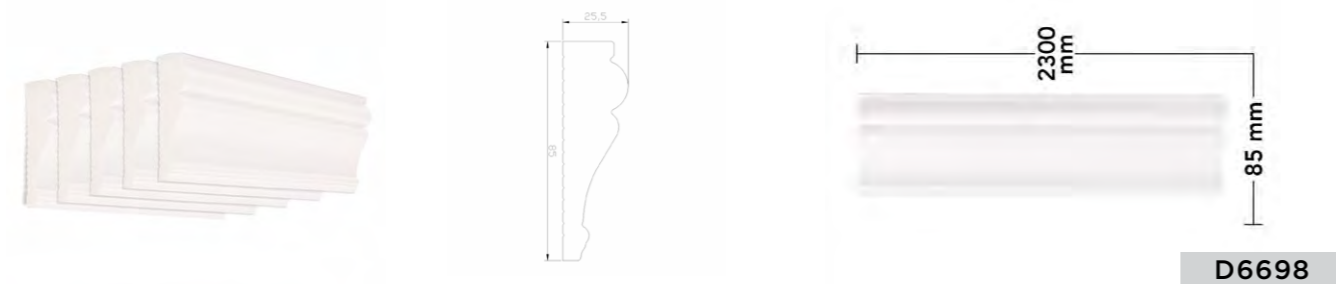

D6698

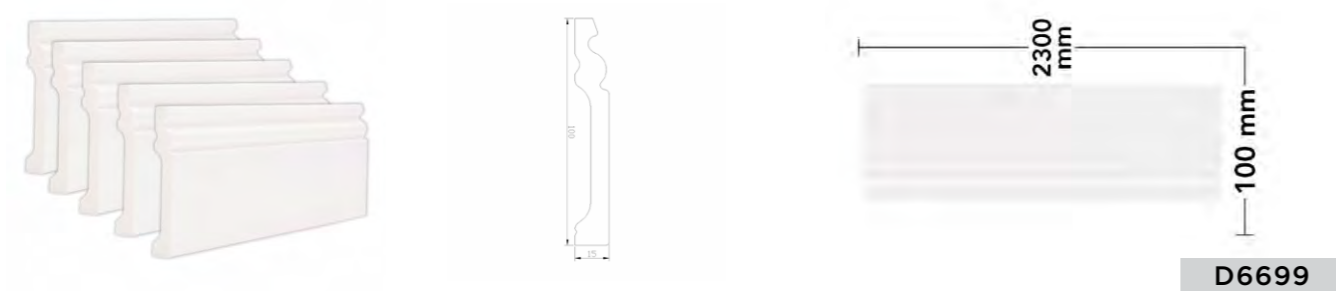

D6699

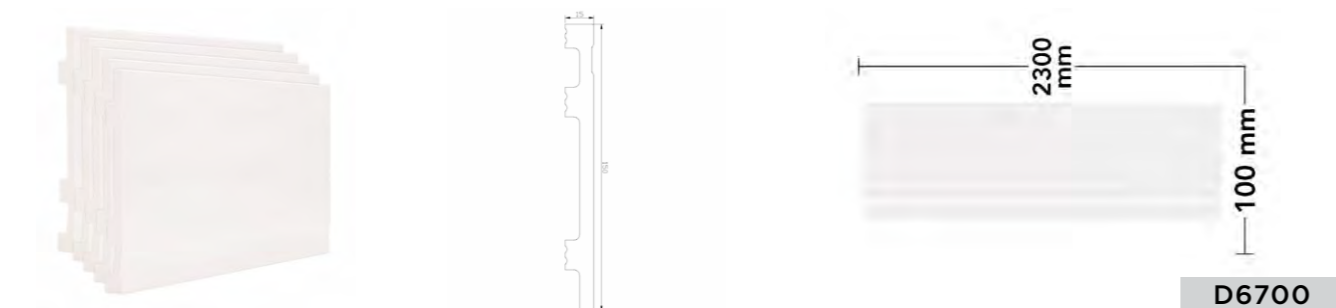

D6700

INNOVATE
& DESIGN
DECORAN

0753.752.921
office@decoran.ro
decoran.ro